



**TEAC®**  
**ESOTERIC**

**SERVICE MANUAL**

---

**R-9000/V-9000**

**STEREO CASSETTE DECK**

---

# R-9000/V-9000

## 1 SPECIFICATIONS

**Track System** 4-Track, 2-Channel Stereo  
**Heads R-9000** 4: 2 Erase, 1 Record and 1 Playback (Rotary)

**V-9000** 3: 1 Erase, 1 Record and 1 Playback (Combination)

**Type of Tape** Cassette tape C-60 and C-90 (Philips type)

**Tape Speed** 4.8 cm/sec. (1-7/8 ips)

**Motors** 3: 1 DC Servo motor (for capstan drive)

1 DC motor (for reel drive)

1 DC motor (for ancillary control)

**Wow and Flutter (WRMS)**

0.03% (R-9000), 0.025% (V-9000)

**Frequency Response (Overall)** -20 dB

20 - 21,000 Hz Metal Tape

(25 - 20,000 Hz  $\pm$  3 dB)

20 - 20,000 Hz CrO<sub>2</sub> Tape

(25 - 19,000 Hz  $\pm$  3 dB)

20 - 18,000 Hz Normal Tape

(25 - 17,000 Hz  $\pm$  3 dB)

**Signal-to-Noise Ratio (Overall)**

60 dB (NR OFF 3% THD Level, Weighted)

70 dB (Dolby B In, over 5 kHz),

80 dB (Dolby C In, over 1 kHz),

**Fast Winding Time** Approximately 70 seconds for C-60

**Inputs** CD direct/Line: 60 mV, 50k ohms  
**Outputs** Line: 0.775 V for load impedance of 50k ohms or more

Headphones: 40 mW (max.), 8 ohms

**Power Requirements** 100/120/220/240 V AC, 50/60 Hz (General export models)

120 V AC, 60 Hz (U.S.A./Canada)

220 V AC, 50 Hz (Europe)

240 V AC, 50 Hz (U.K./Australia)

**Power Consumption** 28 W

**Dimensions** (W x H x D)

476 x 149 x 355 mm

(18-5/8" x 5-7/8" x 14")

**Weight** 10.2 kg (22.5 lbs.)

**Standard Accessories**

Wireless Remote Control Units

RC-366 (R-9000), RC-365 (V-9000),

Batteries (SUM-3, "AA", "R6"

type) x 2, Input-output connection

cords

- Specifications were determined using metal tape except as noted.
- Improvements may result in specifications or features changing without notice.
- Photos and illustrations may differ slightly from production models.

• Dolby noise reduction manufactured under license from Dolby Laboratories Licensing Corporation. "DOLBY" and the double-D symbol [D] are trademarks of Dolby Laboratories Licensing Corporation.

### CAUTION

△ Parts marked with this sign are safety critical components. They must always be replaced with identical components—refer to the appropriate parts list and ensure exact replacement.

## 仕様

トラック形式	4トラック2チャンネル・ステレオホニック方式
ヘッド構成	<R-9000>: 消去ヘッド×2, 録音×1・再生×1 コンビネーションヘッド(ロータリー式) <V-9000>: 消去ヘッド×1, 録音×1・再生×1 コンビネーションヘッド(固定式)
使用テープ	C-60, C-90タイプ カセット・テープ
テープ速度	4.8センチ
モーター	キャプスタン: DC サーボモーター×1 リール: DC モーター×1 メカニズム: DC モーター×1
ワウ・フラッター	<R-9000>: 0.03% (W.RMS), ±0.055% (W.Peak EIAJ) <V-9000>: 0.025% (W.RMS), ±0.045% (W.Peak EIAJ)
周波数特性 (総合)	20Hz~21,000Hz (25Hz~20,000Hz ± 3dB, EIAJ): マタル 20Hz~20,000Hz (25Hz~19,000Hz ± 3dB, EIAJ): クローム 20Hz~18,000Hz (25Hz~17,000Hz ± 3dB, EIAJ): ノーマル
総合S/N比	60dB (NR OFF, 3% THDレベル, WTD) 70dB (ドルビー-B NR IN 5kHz以上) 80dB (ドルビー-C NR IN 1kHz以上)
早巻時間	C-60テープで約70秒
入力	CDダイレクト/ライン: 60mV (入力インピーダンス50kΩ)
出力	ライン: 0.3V (負荷インピーダンス50kΩ以上) ヘッドホン: 40mW (Max) (8Ω)
電源	100V AC, 50/60Hz
消費電力	28W
外形寸法	472(幅)×149(高さ)×355(奥行)mm
重量	10.2kg
付属品	入出力コード2本(1組), リモコン(RC-366<R-9000>, RC-365<V-9000>)乾電池(単3)×2

※この仕様は特に表示した項目を除き、当社標準テープを使用して測定したものです。

※仕様および外観は、改善のため予告なく変更することがあります。

- ドルビーノイズリダクションはドルビーポラトリーズライセンシングコーポレーションの実施権に基づき製造されています。
- ドルビー、DOLBY及びダブルD記号  はドルビーポラトリーズライセンシングコーポレーションの登録商標です。

## 注意

△印は安全重要部品です。交換する時は必ずティアック指定の部品を使用してください。

R-9000/V-9000

## 2 REMOVAL OF EXTERNAL COMPONENTS

外装部品の外し方

Disassemble in number-order  
番号順に外して下さい

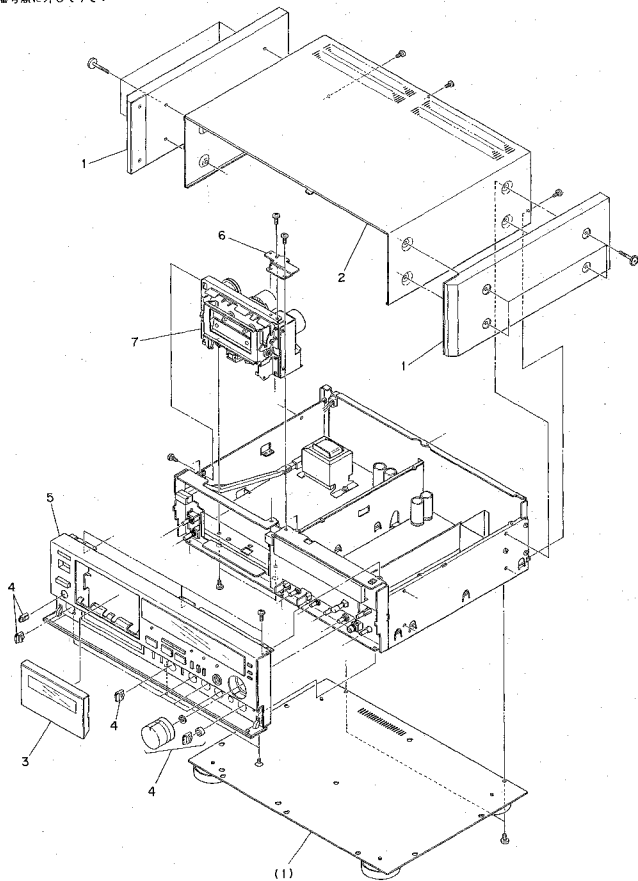

## 3 PARTS LOCATION

部品配置図

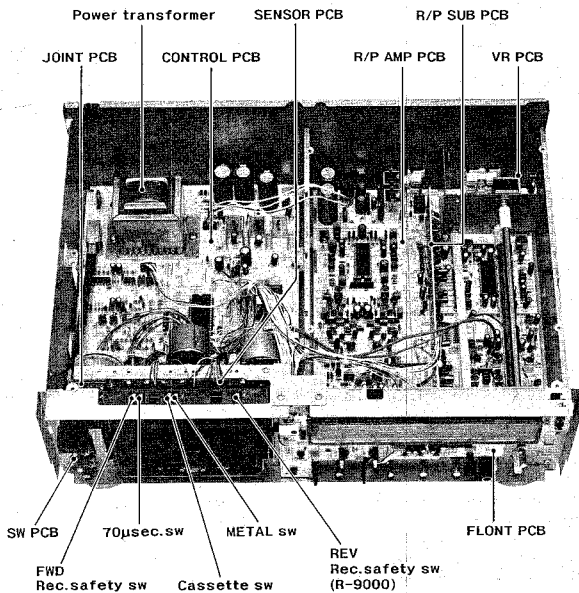

Fig. 3-1

## 4 MECHANICAL ADJUSTMENTS AND CHECKS

### 機構部の調整と確認

#### 4-1 PINCH ROLLER PRESSURE

- Press the cassette switch (see Fig. 3-1) up to set the deck to the playback mode.  
The cassette switch should be pressed up to through-out measurement.
- Hang the spring scale from the pinch roller arm.
- Extend the spring in the direction shown in the figure until the rotation of the pinch roller stops, then return it gradually so that the pinch roller comes into contact with the capstan shaft again.
- Read the value at the moment the pinch roller starts rotating.

#### Standard values

R-9000 FWD/REV play	: 380g—480g (13.4oz—16.9oz)
V-9000 Take-up side	: 390g—490g (13.8oz—17.3oz)
Supply side	: 170g—230g ( 6.0oz— 8.1oz)

#### V-9000

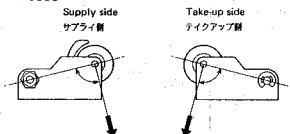

Fig. 4-1 Pinch roller pressure measurement

#### 4-2 TAPE PATH ADJUSTMENT

Note : The following special tools and tapes are required for this section.

- Head check jig A (P/N 5736006600)
- Head check jig B (P/N 5736006700)
- MTI-150 test tape (for Dolby level calibration)
- MTI-356 (or MTI-256) test tape (for frequency response check)
- MTI-902 mirror tape (C-90 type)

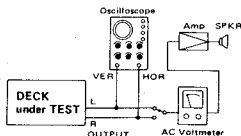

Fig. 4-2 Test setup for azimuth adjustment

#### 4-1 ピンチ・ローラ圧着力

- カセット・スイッチ (Fig. 3-1 参照) を上方に押し上げてプレイ・モードにする。  
測定中、カセット・スイッチは上方に押し続けること。
- ピンチ・ローラ・アームにバネ秤を掛ける。
- 秤をピンチ・ローラの回転が止まるまで図示の方向に引張った後、ピンチ・ローラが再びキャプスタン・シャフトに接触するよう徐々に戻す。
- ピンチ・ローラが回り始めるときの値を読む。

規格値 R-9000 FWD/REV プレイ	: 380g—480g
V-9000 テイクアップ側	: 390g—490g
サプライ側	: 170g—230g

#### R-9000

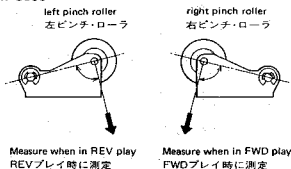

#### 4-2 テープ走行調整

注 : この調整を行うためには次の治具、テスト・テープが必要である。

- ヘッド治具 A (P/N 5736006600)
- ヘッド治具 B (P/N 5736006700)
- テスト・テープ
- MTI-150 : ドルビー・レベル・セット用
- MTI-356 又は MTI-256 : 周波数特性測定用
- MTI-902 : ミラー・テープ (C-90型)

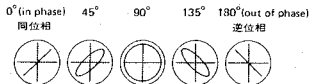

Fig. 4-3 Confirming phase relationship

## R-9000

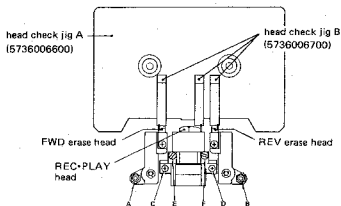
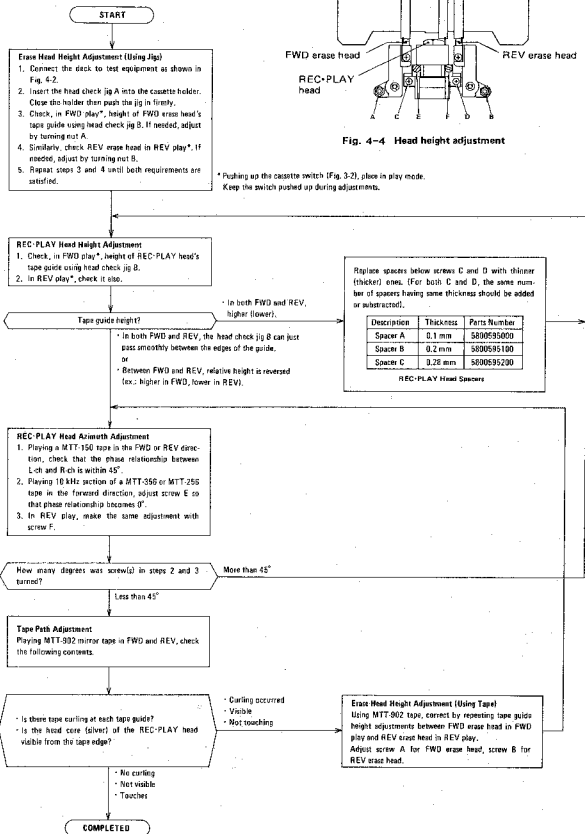

Fig. 4-4 Head height adjustment



## R-9000

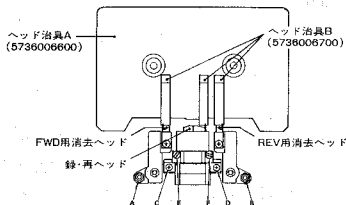
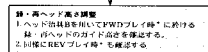
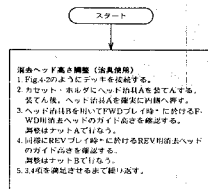

Fig. 4-4 ヘッド高さ調整

・カセット・スイッチ(付)を上方に押し、プレイ・モードにする。  
プレイ・モード中、スイッチは上方に押し続けると、



ガイド高さは?

FWD,REV 高い(低い)場合

- ・FWD,REV両ヘッド治具Bがガイド溝に完全に入る
- 又は
- ・FWD,REVで高さが異なる場合 (例：FWD時高い、REV時低い)

ネジC, Dの下のスペースを極厚の薄い(厚い)ものに交換する。  
(C, Dは同じ厚さのものに同枚数増減すること。)

名称	厚さ	品番
スペースA	0.1mm	5800595000
スペースB	0.2mm	5800595100
スペースC	0.28mm	5800595200

録・再ヘッド用スペース

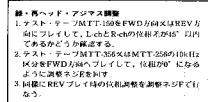

±22.5度程度の位相転じたか?

45°以上

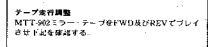

各テープ・ガイドでテープがカールしないか?  
録・再ヘッドのコア(銀色)がテープよりはみ出して見えないか?

・カールする  
・見える  
・残らない

・カールしない  
・見えない  
・残す

**消去ヘッド高さ調整 (テープ使用)**

MTT-302テープを走行させて、FWDプレイ時のFWD用消去ヘッド・ガイド高さ調整とREVプレイ時のREV用消去ヘッド・ガイド高さ調整を繰り返して不良を修正する。FWD用消去ヘッドはネジAで、REV用消去ヘッドはネジBで調整を行なう。

完了



## V-9000

Note 1 : When the record/playback head has been replaced, tighten screws (A), (B), (C) shown in Fig.4-7 until they stop, then slacken them by 1-1/2 turns before starting alignment.

Note 2 : When the erase head has been replaced, install it as shown in Fig.4-8.

1. Attach head position alignment jigs A and B, then set the deck to the play mode.
2. Fit jig B on the tape guide of the record/playback head as shown in Fig.4-5, then align the height with screw (A) as shown in Fig.4-7.
3. Fit jig B to the head as shown in Fig.4-6 to check its tilt and align it using screws (B) and (C) shown in Fig.4-7.  
Then align the height again with screw (A).
4. Repeat alignments in procedure 2 and 3 two or three times to align height and tilt. (When adjusted to the standard height, the head should be under the tape guide.)
5. Fit jig B to the tape guide of the left pinch roller and align the height with nut (E). (The standard height is above the tape guide.)
6. Play test tape MTT-902, and adjust nut (E) so that the lower edge of the tape guide of the record/playback head is in contact with the tape edge, but the tape is not curled.
7. Adjust the azimuth of the playback head with screw (C) shown in Fig. 4-7 according to item 5-3 (on page 18 ). If the screw is rotated by half a turn or more, turn screw (A) and (B) by the same amount then align from item 6 to correct the height of the tape guide of the record/playback head.
8. After alignment is complete, check the tape does not curl over the tape guide by repeating play and stop operations.

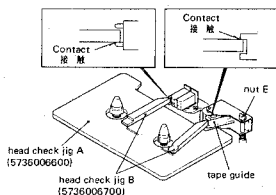

Fig. 4-5

注 1. 録・再ヘッドを交換したときは、Fig.4-7 のネジ(A)、(B)、(C) が止まるまで締め、その位置からそれぞれのネジを 1.5 回転ゆるめた状態で調整を始めること。

注 2. 消去ヘッドを交換したときは、Fig.4-8 のように取付ける。

1. ヘッドの位置調整治具 A, B をセットしプレイ・モードにする。
2. Fig.4-5 のように録・再ヘッドのテープ・ガイドに治具 B を当て、Fig.4-7 のネジ (A) で高さを調整する。
3. Fig.4-6 のように治具 B をヘッドに当ててチルトを確認し、Fig.4-7 のネジ (B), (C) で調整した後、再度ネジ (A) で高さを調整する。
4. 上記 2,3 項の調整を 2~3 回繰り返し、高さ、チルトを調整する。(高さの基準はテープ・ガイドの下側とする。)
5. 左ピンチ・ローラのテープ・ガイドに治具 B を当て、ナット (E) で高さを調整する。(高さの基準はテープ・ガイドの上側とする)。
6. テスト・テープ MTT-902 を走行させ、録・再ヘッドのテープガイドの下側がカールしない程度に当るようナット (E) を調整する。
7. 再生ヘッドのアジマス を 5-3 項 (18 ページ参照) に従って Fig.4-7 のネジ (C) で調整する。  
1/2 回転以上回したときは録・再ヘッドのテープ・ガイド高さを合わせるため、ネジ (A), (B) も同量回し再度 6 項に戻り調整をやりなおす。
8. 全ての調整の後、プレイ・ストップを繰り返して、テープ・ガイドでテープがカールしないことを確認する。

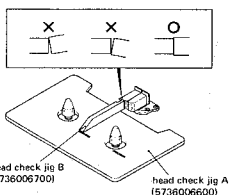

Fig. 4-6

# R-9000/V-9000

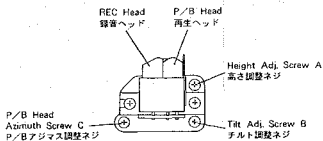

Fig. 4-7

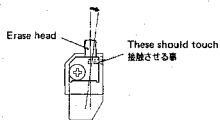

Fig. 4-8

## 4-3 PHOTO SENSOR ADJUSTMENT (R-9000)

1. Connect DC voltmeter as shown in Fig. 4-9.
2. Playing in REV direction, magnetic tape portion of test tape consists of elements in Fig. 4-10 (MT-5511 tape, etc.) adjust R57 so that a voltage of 3.0 V is obtained at TP.5(+), TP.6(-).
3. In FWD play, similarly adjust R59 for obtaining a voltage of 2.8 V.
4. Re-check that voltage is REV play does not change from 3.0 V.
5. Set AUTO REVERSE switch in  $\curvearrowright$  position, then play tape in FWD mode from point A in Fig. 4-10. Check that tape motion changes in REV play mode at point B, then changes is FWD play mode at point A.

## 4-3 フォト・センサ調整 (R-9000)

1. DC 電圧計を Fig. 4-9 のように接続する。
2. Fig. 4-10に示す構成のテスト・テープ (MT-5511 等) の磁気テープ部分を REV プレイで走行させたとき、TP. 5(+), TP. 6(-)の電圧が 3.0 V になるよう R57 を調整する。
3. 同様に FWD プレイで走行させ、TP の電圧が 2.8 V になるよう R59 を調整する。
4. REV プレイ時に TP の電圧が 3.0V から変わらないことを再確認する。
5. AUTO REVERSE スイッチを  $\curvearrowright$  位置にセットし、テープを Fig. 4-10 の A 点より FWD プレイさせる。テープが B 点の位置で REV プレイに反転し、その後 A 点の位置から再び FWD プレイ動作することを確認する。

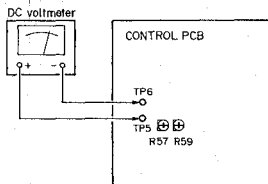

Fig. 4-9 Photo sensor adjustment (1)

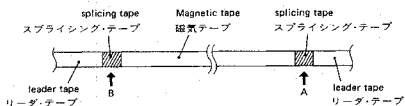

Fig. 4-10 Photo sensor adjustment (2)

## 4-4 REEL TORQUE CHECKS AND ADJUSTMENTS

1. Using a cassette torque meter, check that reel torque at each tape transport operation is within the following specified range.

	V-970X	R-919X
Take-up	25 ~ 60 g·cm (0.34 ~ 0.83 oz·inch)	25 ~ 60 g·cm (0.34 ~ 0.83 oz·inch) (FWD/REV)
*Back Tension	0.40 ~ 0.56V	0.40 ~ 0.52 (FWD/REV)
Fast Forward/ Rewind	90 ~ 160 g·cm (1.25 ~ 2.22 oz·inch)	

## \*Back Tension

1. Connect a DC voltmeter between TP.1 and TP.2(GND) (FWD), TP.3 and TP.4(GND) (REV) on the CONTROL PC board.
2. Play the middle part of test tape HIT-5511 and adjust the following so that the voltmeter shows the values in the above table.  
R-9000: R31 (FWD), R32 (REV)  
V-9000: R31

## 4-5 TAPE SPEED ADJUSTMENT

1. Connect a frequency counter to the deck as shown in Fig. 4-11.
2. Playing the mid portion of an HIT-111 test tape in FWD and REV directions, adjust the semi-fixed resistor on capstan motor so that tape speed becomes 3,000 Hz  $\pm$  5 Hz. An insulate and non-metallic flat-head screwdriver should be used for this adjustment.
3. In both FWD and REV play modes, check that the following values are obtained at the beginig and at the end of the tape.  
Deviation: 3,000 Hz  $\pm$  45 Hz  
Width of deviation: Within 30 Hz

## 4-4 リール・トルク確認及び調整

1. カセット型トルク・メータによる測定値が下表の範囲内であることを確認する。

	V-970X	R-919X
テイクアップ・トルク	25~60 g・cm	25~60 g・cm (FWD/REV)
*バックテンション・トルク	0.40~0.56V	0.40~0.52V (FWD/REV)
早送りトルク (F.F.,REW共)	90~160g・cm	90~160g・cm

## \*バック・テンション

1. DC 電圧計を、FWD は CONTROL PCB の TP.1 と TP.2 (GND) に、REV は TP.3 と TP.4(GND)に接続する。
2. テスト・テープ HIT-5511 の中央付近を再生し、電圧計の指示が上表の値になるよう調整する。  
R-9000 : R31 (FWD), R32 (REV)  
V-9000 : R31

## 4-5 テープ速度調整

1. Fig. 4-11のように周波数カウンタをデッキに接続する。
2. HIT-111 テープ・テストの中間部を FWD,REV それぞれで再生して、テープ速度が 3,000 Hz  $\pm$  5 Hz になるようにキャプスタン・モータの半固定抵抗を調整する。調整には絶縁された非金属製マイナス・ドライバを使用すること。
3. FWD,REV それぞれに於て、テープの巻始めと巻終りにて下表の値が得られることを確認する。  
偏差 : 3,000 Hz  $\pm$  45 Hz  
変動巾 : 30 Hz 以内

# R-9000/V-9000

## 4-6 WOW AND FLUTTER CHECKS

Note: In both FWD and REV play modes, these measurements should be made at the beginning, middle and the end of the tape.

### 4-6-1 PLAYBACK METHOD

1. Connect a wow and flutter meter to the deck as shown in Fig. 4-11.
2. Load a TEAC MIT-111 test tape or equivalent and, in FWD and REV directions, play it to measure the wow and flutter value.
3. Specifications are shown below.  
0.055% WRMS (R-9000)  
0.050% WRMS (V-9000)

### 4-6-2 RECORD/PLAYBACK METHOD

Note: When measuring with this method, the recorded section should be played back repeatedly to obtain an average value.

Be careful not to read the meter for those parts of the tape in which wow and flutter components in recording and playback cancel each other.

4. Load a blank TEAC MIT-5511 test tape or equivalent and record a 3,000 Hz signal in FWD (REV) direction.
5. Rewind (fast forward) the tape to the beginning of the recorded section, and play it in the FWD (REV) direction.
6. The wow and flutter should not be more than specified.  
Specification: 0.3% RMS (R-9000)  
0.25% RMS (V-9000)

## 4-6 ワウ・フラッタ確認

注意: FWD, REV 共、テープの巻始め、中間、巻終りでそれぞれ測定する。

### 4-6-1 再生法

1. Fig. 4-11 のようにワウ・フラッタ・メータをデッキに接続する。
2. TEAC MIT-111 テスト・テープ又は相当品を装てん後、FWD 及び REV の両方向で再生しワウ・フラッタ値を測定する。
3. 規格 0.055% WRMS (聴感補正) .....R-9000  
0.050% WRMS (聴感補正) .....V-9000

### 4-6-2 録再法

注意: 本測定法の場合、録音した部分を幾度かストップ、再生を繰返し、大きく振れる平均的な値を讀む。録音した時と再生した時のワウ・フラッタ成分の位相がキャンセルしたところを讀まないようにする。

4. ブランク・テスト・テープ TEAC MIT-5521 又は相当品を装てんし、3,000 Hz 信号を FWD (REV) 方向で録音する。
5. テープの録音した部分を巻戻して FWD (REV) 方向で再生する。
6. ワウ・フラッタ値は下記の値から外れないこと。  
規格: 0.3% RMS (非聴感補正) (R-9000)  
0.25% RMS (非聴感補正) (V-9000)

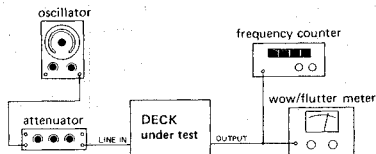

Fig. 4-11 Connection for tapespeed, wow and flutter

## 4-7 LUBRICATION

Lubrication is only required when parts are replaced. For this purpose, use the oil and grease specified below.

Oil: TEAC TZ-255A motor oil (from TEAC TZ-255 oil kit), Mobil D.T.E. Oil Light, or equivalent

Grease: ORE-LUBE G1/3 or equivalent

1. Apply a drop of oil with an oil applicator to a point about 1/3 the way down the shaft (from the free end) of the flywheel, then insert the shaft into the capstan housing.
2. Apply a suitable amount of light grease to the well of the flywheel bearing.

## 4-7 注油

注油は部品が交換される時のみ必要です。注油には下記に明示するオイルとグリースを使用します。

オイル: TEAC TZ-255A モーターオイル (TEAC TZ-255 オイルキットから)

モービル D・T・E オイル・ライト、または相当品

グリース: オア・ループ G1/3、または相当品

1. フライホイール軸の先端から約 1/3 下った軸面へ、注油器にてオイル 1 滴を注油後、フライホイール軸をキャプスタン・ハウジングへさそう入する。
2. 適量のグリースをフライホイール・ベアリング受けへつける。

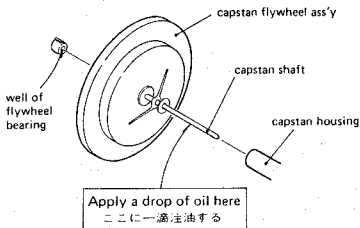

Fig. 4-12

## 4-8 VOLTAGE CONVERSION

(FOR GENERAL EXPORT MODELS)

ALWAYS DISCONNECT THE POWER LINE CORD BEFORE MAKING THESE CHANGES.

1. Locate the voltage selector on the rear panel of the deck as shown in the illustration.
2. Using a regular screwdriver, turn the selector until the numerals corresponding to the voltage requirements of your area appear.

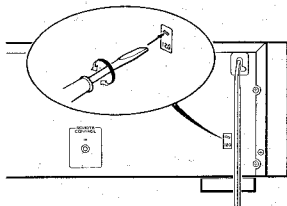

Fig. 4-13

## 5 ELECTRICAL CHECKS AND ADJUSTMENTS

## アンプ部の確認と調整

## 5-1 PRECAUTIONS

1. Since this deck has an automatic tape selector, be sure to use test tapes that have tape position detecting holes.
2. Before performing adjustments and checks, clean and demagnetize the entire tape path, then check tape motion condition.
3. Make sure the deck is properly set for the voltage in your locality.
4. In general, adjustments and checks are made in the order of L-ch then R-ch.  
Double REF. Nos. such as R129/R229 indicate L-ch/R-ch.
5. The AC voltmeter used in the procedures must have an input impedance of 1 M $\Omega$  or more.
6. 0 dB is referenced to 0.775 V.

## 5-2 TEAC TEST TAPES

- MTT-150C : For Dolby level calibration  
 MTT-25707 : For R-P head azimuth adjustment and playback frequency response check  
 MTT-15000 : For playback S/N check (Dolby NR B,C)  
 MTT-905 : For quick sensor adjustment (R-9000 only)  
 MTT-5571 : For METAL record test  
 MTT-5561 : For CrO<sub>2</sub> record test  
 MTT-5511 : For NORHAL record test

## 5-1 準備

1. 本機はテープ・セレクト自動検出機構になっていますのでテスト・テープは必ずテープ・ポジション検出孔のあるものを使用してください。
2. アンプ部の調整のまえに、消去ヘッド、録・再ヘッド、テープ走行部分それぞれを充分消磁し、クリーン液で清掃した後、テープの走行状態を確認してください。
3. 特に指定の無い限り、調整及びチェックは L-ch、R-ch の順序で行ってください。  
尚、R129/R229 のように記されている回路番号は、L-ch/R-ch を示します。
4. レベル計は入力インピーダンス 1 M $\Omega$ 以上のものを使用してください。
5. 0 dB = 0.775 V

## 5-2 TEAC テスト・テープ

- MTT-150C : ドルビー・レベル・セット用  
 MTT-25707 : 録・再ヘッドのアジマス調整、及び再生周波数特性測定用  
 MTT-15000 : 再生 S/N (Dolby NR B,C) 測定用  
 MTT-905 : クイック・センサー調整用 (R-9000のみ)  
 MTT-5571 : METAL テープの録音系テスト用  
 MTT-5561 : Cr O<sub>2</sub> テープの録音系テスト用  
 MTT-5511 : NORHALテープの録音系テスト用

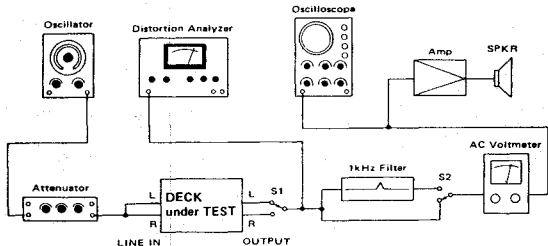
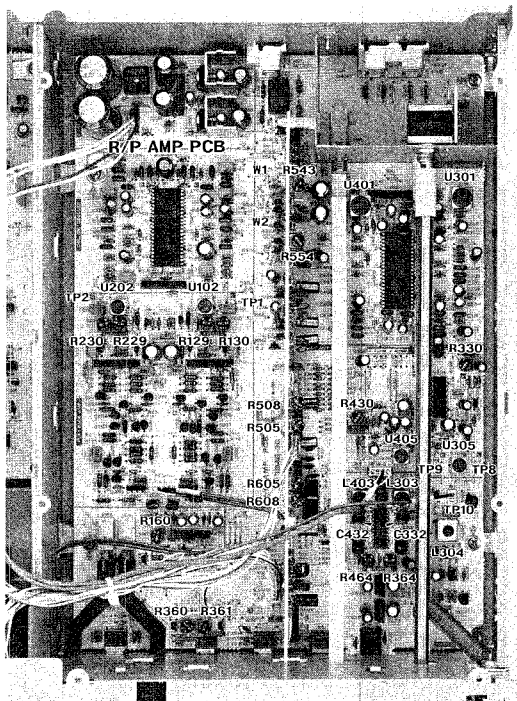

Fig. 5-1 Basic test setup



R129/R229	Playback dolby level
R130/R230	Playback EQ
R160	CPS level
R330/R430	Record level
R360	Record bias(CrO <sub>2</sub> )
R361	Record bias(NORMAL)
R364/R464	Record bias
R505/R605	Meter level

R508/R608	Peak level
R543	Built-in OSC(10kHz level)
R554	Built-in OSC(400Hz level)
L303/L403	Step-up coil
L304	Bias OSC
U102/U202	Bias trap(Playback)
U301/U401	MPX filter
U305/U405	Bias trap(Record)

Fig. 5-2 Check and adjustment points on R/P AMP PCB

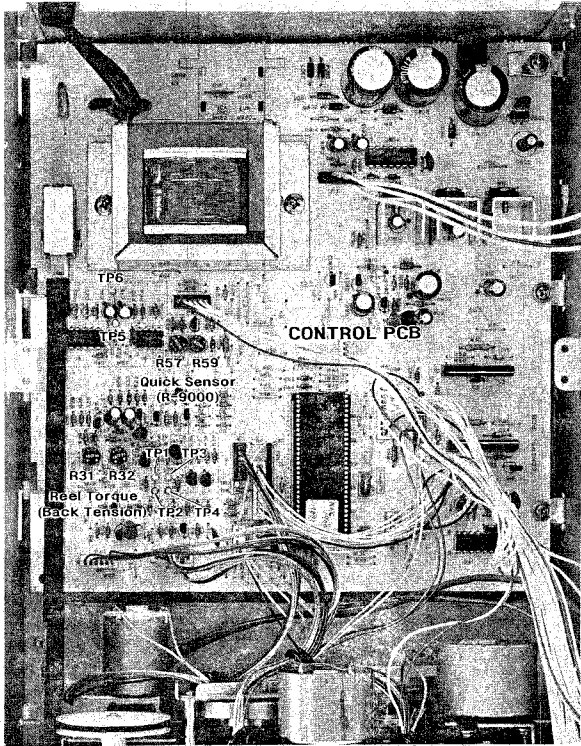

Fig. 5-3 Check and adjustment points on CONTROL PCB



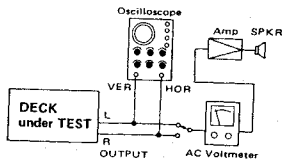

Fig. 5-4 Test setup for azimuth check

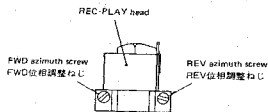

Fig. 5-5 (R-9000)

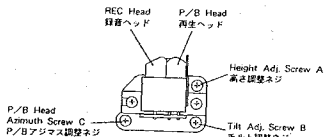

Fig. 5-6 (V-9000)

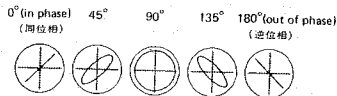

Fig. 5-7 Confirming phase relationship

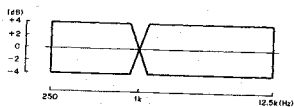

Fig. 5-8 Playback frequency response

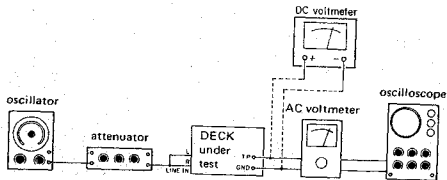

Fig. 5-9 Test setup for test point check

# R-9000/V-9000

## 5-3. PLAYBACK PERFORMANCE 再生系

Deck settings  
 Mode : PLAY  
 AUTO MONITOR sw. : TAPE  
 DOLBY NR sw. : OFF  
 HPX FILTER sw. : OFF  
 CAL ON sw. : OFF  
 CD DIRECT sw. : OFF

TEAC test tapes :  
 HTT-150C : For Dolby level calibration  
 HTT-25707 : For R - P head azimuth adjustment and  
 playback frequency response check  
 HTT-5571 : For S/N check for 70  $\mu$ sec (METAL)  
 HTT-5511 : For S/N check for 120  $\mu$ sec (NORMAL)  
 HTT-15000 : For S/N check for DOLBY NR B, C

ITEM 調整項目	SETTING 設定	INPUT SIGNAL 入力信号	ADJUST (or CHECK) 調整箇所	MEASURING POINT, RESULT 測定箇所・調整値	REMARKS 備考
1. REC - PLAY head azimuth 録・再ヘッド アジマス	Connection : Fig.5-4	HTT-25707 (8kHz)	Azimuth screws of R - P head 録・再ヘッドの アジマス調整ネジ R-9000 Fig.5-5 V-9000 Fig.5-6	OUTPUT (L/R) : Phase between L-ch and R-ch : 0° Maximum output at L- & R-ch'S. L-R 間の位相差が 0° で 且つ各 ch 共最大出力	Refer to Fig.5-7
2. Playback Dolby level 再生ドルビー レベル	Same as above 同上	HTT-150C	R129/R229	TP.S/TP.4 : -10 dB (245mV)	
3. Playback output level 再生出力レベル	Same as above 同上	HTT-150C	Check	R-9000 OUTPUT (L/R) : FWD -1 $\pm$ 1 dB (615~775mV) REV -1 $\pm$ 1.5dB (581~820mV) V-9000 OUTPUT (L/R) : FWD -1 $\pm$ 1 dB (615~775mV)	
4. Meter level setting メーター・レベル セット	Same as above 同上	HTT-150C	R505/R605	PEAK LEVEL meter (L/R) : 00 (-1 dB)	
5. Playback frequency response 再生周波数特性	Same as above 同上	HTT-25707	R130/R230  Check	OUTPUT (L/R) : Equal output level between 8 kHz and 1 kHz 8 kHz と 1 kHz の出力が等しくなる よう調整  Standard 規格 : Fig.5-8	
6. Playback S/N ratio 再生 S/N 比	Same as above 同上 DOLBY NR : OFF	HTT-5571 ( 70 $\mu$ sec) HTT-5511 (120 $\mu$ sec)  Play back the leader tape portion リーダーテープ部を 再生	Check	OUTPUT (L/R) : S/N 45 dB min. (120 $\mu$ s) 46 dB min. ( 70 $\mu$ s)  The reference level of S/N is the output in 3. 3 項の出力を基準レベルとする	
	Same as above 同上 DOLBY NR : OFF $\rightarrow$ B $\rightarrow$ C	HTT-15000	Check	OUTPUT (L/R) : Amount of variation in S/N with respect to the S/N value *1 when the HTT-15000 signal is played back with DOLBY NR OFF. HTT-15000 を DOLBY NR OFF で再生した時の S/N 値 *1 に対する S/N 変化量 DOLBY NR B : 8.5dB or more DOLBY NR C : 17dB or more  *1 : The reference level of S/N is the output in 3. S/N の基準レベルは 3 項の出力	

## 5-4. MONITOR PERFORMANCE

モニター系

Deck settings  
 Mode : RECORD/PAUSE REC LEVEL cont. : Maximum  
 AUTO MONITOR sw. : SOURCE LEVEL cont. : Center  
 DOLBY NR sw. : OFF BALANCE cont. : Center  
 MPX FILTER sw. : OFF  
 CAL ON sw. : OFF  
 CD DIRECT sw. : OFF

TEAC test tapes : HTI-5571 (METAL)

ITEM 調整項目	SETTING 設定	INPUT SIGNAL 入力信号	ADJUST (or CHECK) 調整箇所	MEASURING POINT, RESULT 測定箇所・調整値	REMARKS 備考
7. Min. LINE input level ライン 最小入力レベル	Connection : Fig.5-1 REC LEVEL cont. : Maximum	LINE IN (L/R) : 400 Hz / -19 dB (86.9 mV)	Check	OUTPUT (L/R) : -1 ±3 dB (489 mV ~ 975 mV)	
8. Specified LINE input level LINE 規定入力 レベル	Connection : fig.5-1	LINE IN (L/R) : 400Hz/-9dB(275mV)	REC LEVEL cont.	OUTPUT (L/R) : -1 dB (690 mV)	
		<ul style="list-style-type: none"> <li>• If there is a difference in level between channels, adjust using the BALANCE cont.</li> <li>• チャンネル間レベル差のある場合は BALANCE cont. で調整する。</li> <li>• After adjusting, do not move the REC LEVEL cont. and BALANCE cont. (Specific position)</li> <li>• 調整後は REC LEVEL cont. と BALANCE cont. を動かさないこと。(規定位置)</li> </ul>			
9. CD DIRECT input level CD DIRECT 入力レベル	Connection : fig.5-1 CD DIRECT sw. : ON	LINE IN (L/R) : 400Hz/-9dB(275mV)	Check	OUTPUT (L/R) : -1 ±1 dB (615 mV ~ 775 mV)	
		<ul style="list-style-type: none"> <li>• After checking is complete, set the CD DIRECT SW to OFF.</li> <li>• チェック後、CD DIRECT sw. を OFF に戻すこと。</li> </ul>			
10. Meter level メータ・レベル	Connection : fig.5-1	LINE IN (L/R) : 400Hz/-9dB(275mV)	Check	PEAK LEVEL meter (L/R) : 00 (-1 dB) ±1 dB	
11. Peak level ピーク・レベル	Connection : fig.5-1	LINE IN (L/R) : 400Hz/+6dB(1.55V)	R508/R608	PEAK LEVEL meter (L/R) : Press the DISPLAY and CLEAR buttons alternately, then adjust so that the meter reads +5dB. DISPLAY 鍵と CLEAR 鍵を交互に押し、 メータ表示が +5dB になるよう調整	
12. PHONES output level PHONES 出力レベル	Connection : fig.5-10 PHONES LEVEL cont. : Max.	LINE IN (L/R) : 400Hz/-9dB(275mV)	Check	PHONES : -2 dB ±3 dB (436mV~869mV)	8Ω load
13. MPX filter MPX フィルター	Connection : fig.5-1 MPX FILTER sw. : ON	LINE IN (L/R) : 19kHz/-9dB(275mV)	U301/U401	OUTPUT (L/R) : -31 dB (21.8mV) or less	
		<ul style="list-style-type: none"> <li>• After the checking is complete, set the MPX FILTER SW to OFF.</li> <li>• チェック後、MPX FILTER sw. を OFF に戻すこと。</li> </ul>			
14. Bias osc. バイアス発振器	Connection : fig.5-11 Tape : HTI-5571 (METAL) Mode : RECORD	No signal 無信号	L304	TP. 10 : R-9000 : 150 kHz ( ±2 kHz ) V-9000 : 210 kHz ( ±2 kHz )	

ITEM 調整項目	SETTING 設定	INPUT SIGNAL 入力信号	ADJUST (or CHECK) 調整箇所	MEASURING POINT, RESULT 測定箇所・調整値	REMARKS 備考
15. Step-up coil ステップアップ コイル	Same as above 同上	Same as above 同上	L303/L403	L-ch : Left lead of C332 C332 の左リード R-ch : Right lead of C432 C432 の右リード	Refer to Fig. 5-2
16. Bias trap (REC) バイアス・トラ ップ (録音側)	Connection : Fig. 5-9 Tape : MTI-5571 (METAL) Mode : RECORD	No signal 無信号	U305/U405	TP. 8/TP. 9 : Minimum reading バイアス漏れ最小	
17. Built-in oscillator 内部発振器	Tape : No load 不要 Mode : STOP W1 shorting (Fig. 5-2) W2 shorting (Fig. 5-2)	No signal 無信号		Peak level meter : • Adjust R554 (400kHz) so that the display indication reaches the LEVEL ▼ mark. ディスプレイが LEVEL ▼マークまで点灯するよう R544 (400kHz) を調整する。 • Adjust R543 (10kHz) so that the display indication reaches the BIAS ▲ mark. ディスプレイが BIAS ▲マークまで点灯するよう R543 (10kHz) を調整する。	
				After adjustment complete, open W1 and W2. 調整後は W1, W2 オープンにする。	

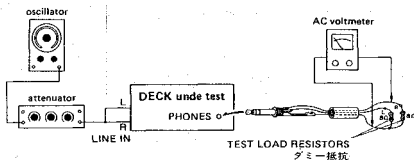

Fig. 5-10 Test setup for PHONES check

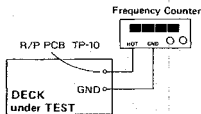

Fig. 5-11 Test setup for bias osc. frequency adjustment

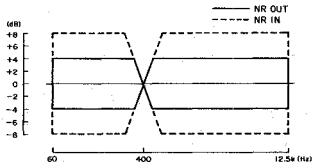

Fig. 5-12 Overall frequency response (NR OUT)

## 5-5. RECORDING PERFORMANCE

## 録音系

Deck settings				
Mode	: Rec/Play	(Item 10, 11)		TEAC recording test tapes
	: Record then Playback	(Item 12~22)		MTI-5571 : For METAL
REC LEVEL cont.	: Specified position	規定位置 (Item 8)		MTI-5561 : For CrO <sub>2</sub>
BALANCE cont.	: Specified position	規定位置 (Item 8)		MTI-5511 : For NORMAL
BIAS cont.	: Center	DOLBY NR sw. : OFF		
LEVEL cont.	: Center	MPX FILTER sw. : OFF		
AUTO MONITOR sw.	: TAPE	CAL ON sw. : OFF		

ITEM 調整項目	SETTING 設定	INPUT SIGNAL 入力信号	ADJUST (or CHECK) 調整箇所	MEASURING POINT, RESULT 測定箇所・調整値	REMARKS 備考
18. Record bias -1 仮バイアス セット	Connection : Fig.5-1 Tape : MTI-5571 (METAL) Mode : REC / PLAY	LINE IN (L/R) : 400 Hz and 10 kHz alternately 交互信号 -42 dB (6.15 mV)	R364/R464	OUTPUT (L/R) : Equal output level between 400 Hz and 10kHz. 400Hz と 10kHz の録再出力が等しく なること	
19. Record bias -2 バイアス セット	Connection : Fig.5-1 Tape : MTI-5511 (NORMAL) Mode : REC / PLAY	LINE IN (L/R) : 400 Hz and 10 kHz alternately 交互信号 -42 dB (6.15 mV)	R361	OUTPUT (L/R) : Perform adjustment so that the L-ch and R-ch levels of the 400Hz and 10kHz signals are averaged. 400Hz と 10kHz の L-ch, R-ch の各 レベルが平均的になるよう調整	
			R364/R464	OUTPUT (L/R) : Re-adjust equal output level between 400 Hz and 10kHz. 400Hz と 10kHz の録再出力が等しく なるよう再調整する。	
20. Record bias -3 バイアス セット	Connection : Fig.5-1 Tape : MTI-5561 (CrO <sub>2</sub> ) Mode : REC / PLAY	LINE IN (L/R) : 400 Hz and 10 kHz alternately 交互信号 -42 dB (6.15 mV)	R360	OUTPUT (L/R) : Perform adjustment so that the L-ch and R-ch levels of the 400Hz and 10kHz signals are averaged. 400Hz と 10kHz の L-ch, R-ch の各 レベルが平均的になるよう調整	
21. Record level 録音レベル	Connection : Fig.5-1 Tape : MTI-5511 (NORMAL) Mode : REC / PLAY  DOLBY NR : OFF/B/C Tape : MTI-5571 (METAL) Tape : MTI-5581 (CrO <sub>2</sub> ) Tape : MTI-5511 (NORMAL)	LINE IN (L/R) : 400 Hz / -12 dB (195 mV)	R330/R430	OUTPUT (L/R) : -4 dB (489 mV)	
			Check	OUTPUT (L/R) : DOLBY NR OFF -4 dB ±2 dB (388 mV ~ 615 mV) DOLBY NR B/C -4 dB ±3 dB (346 mV ~ 630 mV)	
22. Total harmonic distortion 総合歪率	Connection : Fig.5-1 DOLBY NR : OFF Tape : MTI-5571 (METAL) Tape : MTI-5561 (CrO <sub>2</sub> ) Tape : MTI-5511 (NORMAL)	LINE IN (L/R) : 400 Hz / -12 dB (195 mV)	Check	OUTPUT (L/R) : Distortion 歪率 METAL : 2.0 % or less CrO <sub>2</sub> : 2.0 % or less NORMAL : 1.5 % or less	
23. Bias trap (Playback) バイアス・トラ ップ (再生側)	Connection : Fig.5-9 Mode : REC / PLAY	No signal 無信号	U102/U202	TP.1 / TP.2 : Minimum bias leakage バイアス漏れ 最小	
			Check	OUTPUT (L/R) : Bias leakage バイアス漏れ -40 dB (7.75 mV) or less PEAK LEVEL meter : Do not lit 点灯しないこと	

# R-9000/V-9000

ITEM 調整項目	SETTING 設定	INPUT SIGNAL 入力信号	ADJUST (or CHECK) 調整箇所	MEASURING POINT, RESULT 測定箇所・調整値	REMARKS 備考
24. Overall frequency response 録再周波数特性	Connection : Fig. 5-1 Tape : HTI-5571 (METAL) Tape : HTI-5561 (CrO <sub>2</sub> ) Tape : HTI-5511 (NORMAL)	LINE IN (L/R) : 63Hz-12.5kHz / -42 dB (6.15 mV)	Check	OUTPUT (L/R) : METAL DOLBY NR B,C Spec. Fig. 5-12 CrO <sub>2</sub> DOLBY NR B,C Spec. Fig. 5-12 NORMAL DOLBY NR OFF Spec. Fig. 5-12	
25. Overall S/N ratio 総合 S/N 比	Connection : Fig. 5-1 Tape : HTI-5571 (METAL) Tape : HTI-5561 (CrO <sub>2</sub> ) Tape : HTI-5511 (NORMAL)	No signal 無信号	Check	OUTPUT (L/R) : METAL 46 dB min. CrO <sub>2</sub> 46 dB min. NORMAL 45 dB min.  400Hz/-1dB (690mV) is the reference level. 基準レベルは 400Hz/-1dB (690mV)	
26. Built-in osc. (BIAS, LEVEL)	Tape : HTI-5511 (NORMAL) Mode : REC / PLAY CAL ON sw. : ON LEVEL cont. : Center BIAS cont. : Center	No signal 無信号	Check	PEAK LEVEL meter indication : LEVEL ▼ ±4 dot BIAS ▲ ±5 dot	
	Tape : HTI-5511 (NORMAL) Mode : REC / PLAY CAL ON sw. : ON LEVEL cont. : Center Fully "-" to fully "+"	No signal 無信号	Check	PEAK LEVEL meter indication : Level variation between portion "-" and "+" portion "-" と "+" 間のレベル可変幅 6 dot min. 6 ドット以上	
	Tape : HTI-5511 (NORMAL) Mode : REC / PLAY CAL ON sw. : ON BIAS cont. : Center Fully "-" to fully "+"	No signal 無信号	Check	PEAK LEVEL meter indication : Level variation between portion "-" and "+" portion "-" と "+" 間のレベル可変幅 5 dot min. 5 ドット以上	
27. Erase efficiency 消去効果	Connection : Fig. 5-1 but engage 1-kHz filter 1-kHz フィルター使用 Tape : HTI-5571 (METAL)	LINE IN (L/R) : 1 kHz / +1 dB (669mV)	Check	OUTPUT (L/R) : 63 dB min. ratio	Record a 1-kHz signal. Erase the latter half of the recording. Rewind and play to find the difference between the 1-kHz portion and the erased portion. 録音部分を再生した時のレベルを基準レベルとし、録音部分を消去した時の出力レベルとの差を測定。
28. REC MUTE function REC MUTE 効果	Same as above 同上	Same as above 同上	Check	OUTPUT (L/R) : 65 dB min. ratio	Record a 1-kHz signal. Push REC MUTE button midway. Rewind and play to find the difference between the 1-kHz portion and the "rec mute" portion. 1-kHz 信号を録音し、途中で REC MUTE 鍵を押して無信号録音部分を作る。このテープを再生し、1-kHz 部分と無信号部分との出力レベル差を測定。
29. Channel separation チャンネルセパレーション	Same as above 同上	LINE IN (L/R) : L-ch 1 kHz / -9dB (275mV) R-ch No signal	Check	OUTPUT (R) : 30 dB min.	Set the deck to record mode, rewind and play to find the difference between the 1-kHz recorded portion (L-ch) and "no signal" portion (R-ch). 録音後、再生して 1-kHz 録音部分 (L-ch) と無信号録音部分 (R-ch) との出力レベル差を測定。 *Change the above connection and check reverse operation also. L-ch と R-ch を入れ替えた場合についてもチェックすること。

ITEM 調整項目	SETTING 設定	INPUT SIGNAL 入力信号	ADJUST (or CHECK) 調整箇所	MEASURING POINT, RESULT 測定箇所・調整値	REMARKS 備考
30. Adjacent track crosstalk トラック間クロストーク	Connection : Fig. 5-1 but do not connect LINE IN (L) and OUTPUT (L). L-ch の入出力の接続不要	LINE IN : L-ch No signal R-ch 125Hz/-9dB (275mV)	Check	OUTPUT (R) : 40 dB min. ratio	
	Record a 125-Hz signal on R-ch track and note output level. Invert tape and play R-ch track. Check leakage level against the output reference of previously recorded portion. R-ch トラックに125 Hz を録音し、その再生出力を基準レベルとする。 次に、テープを反転して再生した時の R-ch 出力レベルと基準レベルとの差を測定。				

## 5-6. CONTROL PERFORMANCE

## 制御系

TEAC test tape

MIT-150C : For CPS level adjustment

MIT-905 : For quick sensor adjustment

ITEM 調整項目	SETTING 設定	INPUT SIGNAL 入力信号	ADJUST (or CHECK) 調整箇所	MEASURING POINT, RESULT 測定箇所・調整値	REMARKS 備考
31. CPS level CPS レベル (R-9000)	Connection : Fig. 5-9	MIT-150C	R160	TP. 5 : -20 dB (77.5mV)	
	At the center of the MIT-150C test tape, measure the output level at TP.5 in each CPS mode including FF in the FWD direction, REW in the FWD direction, FF in the REV direction. Perform adjustment so that the whichever is a higher level (excluding the maximum and minimum levels) among four measured values is -20 dB. MIT-150C のテープ中央部分で、FWD 方向の FF、FWD 方向の REW、REV 方向の FF、REV 方向の REW、各 CPS モード時の TP.5 の出力レベルを測定する。4 つの測定値の内、最大と最小のレベルを除く残りのレベルの大きい方が -20 dB になるように R160 を調整する。				
32. CPS level CPS レベル (V-9000)	Connection : Fig. 5-9	MIT-150C	R160	TP. 5 : -20 dB (77.5mV)	
	At the center of the MIT-150C test tape, measure the output level at TP.5 in FF and REW CPS mode. Perform adjustment so that the whichever is a lower level is -20 dB. MIT-150C のテープ中央部分で、FF/REW の CPS 状態時の TP.5 出力レベルの低いほうが -20 dB になるように R160 を調整する。				
33. Quick sensor クイック センサー (R-9000 only)	Connection : Fig. 5-9 Mode : REV PLAY	MIT-905	R57	DC voltage between TP.5 (+) and TP.6 (GND) : +3.0 V TP.5, TP.6(GND) 間電圧 : +3.0 V	
	Connection : Fig. 5-9 Mode : FWD PLAY	MIT-905	R59	DC voltage between TP.5 (+) and TP.6 (GND) : +2.8 V TP.5, TP.6(GND) 間電圧 : +2.8 V	
	Connection : Fig. 5-9 Mode : REV PLAY	MIT-905	Re-check 再チェック	DC voltage between TP.5 (+) and TP.6 (GND) : +3.0 V TP.5, TP.6(GND) 間電圧 : +3.0 V	

## 6 IC BLOCK DIAGRAMS

ICブロック・ダイアグラム

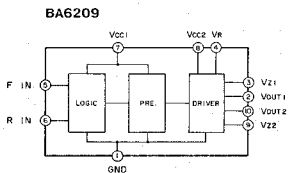
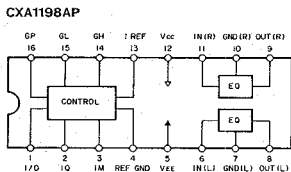
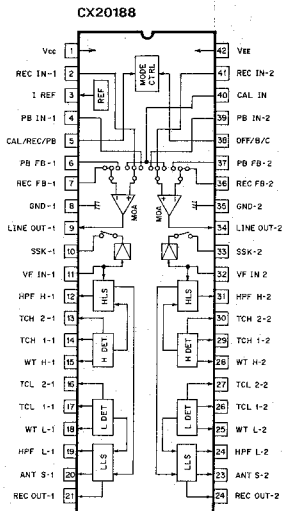

F IN	R IN	Vcc1	VOUT1
H	H	L	L
L	H	L	H
H	L	H	L
L	L	L	L

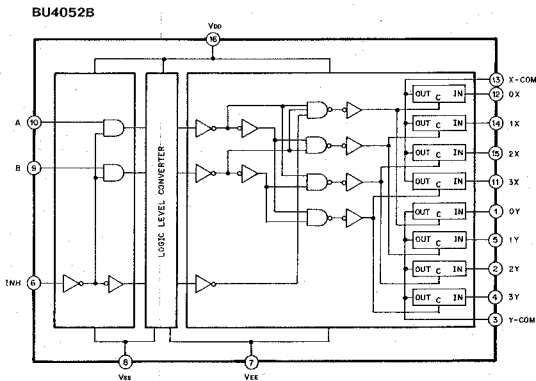



## M51143AL

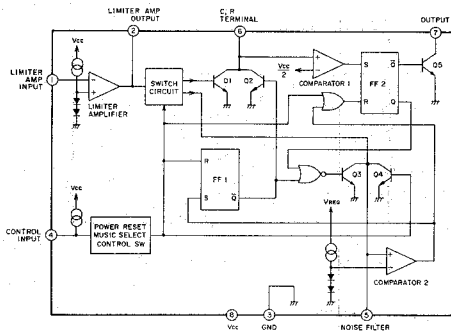

## M5230LA

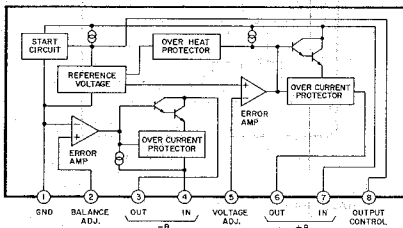

## LB1240

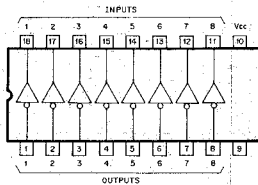

# R-9000/V-9000

## LC7910

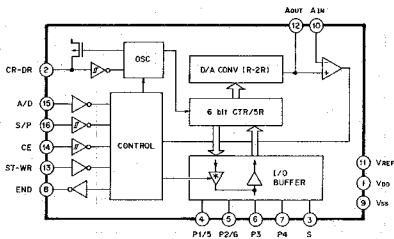

SCHMITT INVERTER, 
 TRISTATE BUFFER, 
 COMPARATOR

## L78LR05

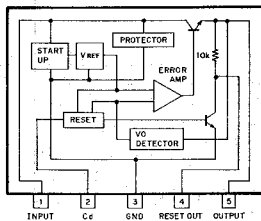

## BA6800AS

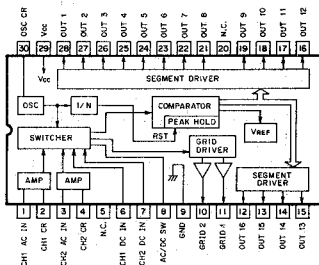

## PARTS LISTS SECTION

### NOTES

As regards the resistors and capacitors, refer to the circuit diagrams and the PCB ass'y drawings contained in this manual.

- Parts marked with \* require longer delivery time.
- $\Delta$  Parts marked with this sign are safety critical components. They must always be replaced with identical components – refer to the TEAC Parts List and ensure exact replacement.
- PC boards shown viewed from parts side.

### 注意

標準の抵抗：コンデンサーは省略してあります。回路図及び基板図を参照してください。

1. プリント基板図は部品面が示されています。
2. \*印の部品は納期が若干かかります。あらかじめご了承ください。
3.  $\Delta$ 印は安全規格重要部品です。交換するときは必ずディック指定の部品を使用して下さい。

# R-9000

## 7 EXPLODED VIEWS AND PARTS LIST

分解図とパーツ・リスト

### EXPLODED VIEW - 1 (R-9000)

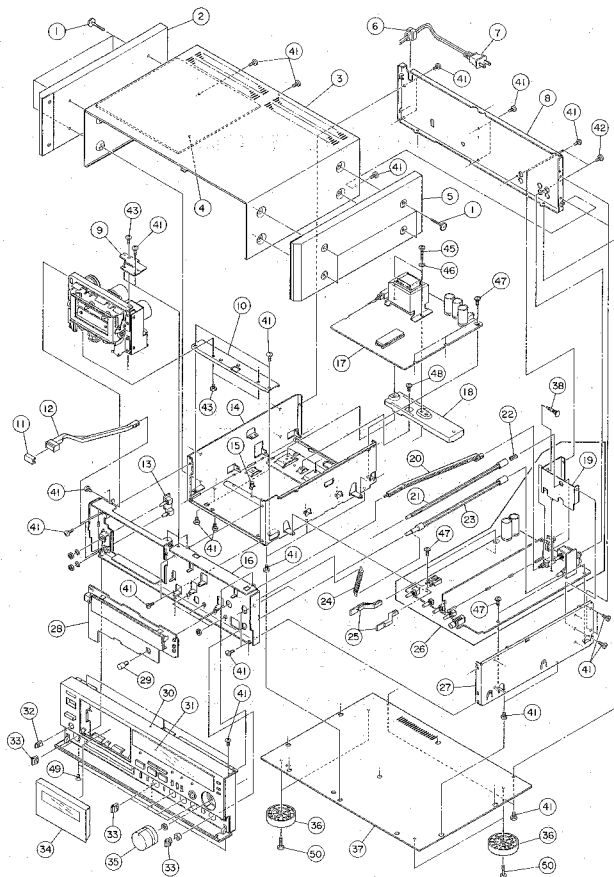

## EXPLODED VIEW-1 (R-9000)

REF. NO.	PARTS NO.	DESCRIPTION	REMARKS
1- 1	*5800954700	SCREW ASSY, SIDE BOARD	
1- 2	*5801353400	BOARD (L), SIDE	
1- 3	*5801342700	BONNET (B)	
1- 4	*5801145700	SHEET (C), DAMPER	
1- 5	*5801353500	BOARD (R), SIDE	
1- 6	*5317003400	BUSHING 2271	
1- 7	Δ*5350015600	CORD, AC [J]	
	Δ*5350010700	CORD, AC [US,C,GE] UL SPT-2	
	Δ*5350011700	CORD, AC [E] OEE CLASS-2	
	Δ*5128047000	CORD, AC [UK] BS	
	Δ*5350008300	CORD, AC [AUS] SAA	
1- 8	*5801342600	PANEL, REAR [EXCEPT GE]	
	*5801353300	PANEL, REAR [GE]	
1- 9	*5801342100	HOLDER, MECHANISM (UPPER)	
1-10	*5801342200	HOLDER, MECHANISM (UNDER)	
1-11	5801340500	CUP (B), POWER (TEAC)	
	5801356100	CUP (G), POWER (ESOTERIC)	
1-12	*5801340400	JOINT, POWER SWITCH	
1-13	*5200305110	SWITCH PCB ASSY	Ref. pages 40 & 43
1-14	*5801343000	CHASSIS, MAIN	
1-15	*5787060700	SPACER, PUSH PS-7 A=11.11	
1-16	*5801342900	CHASSIS, FRONT	
1-17	*5200305250	CONTROL PCB ASSY [J]	Ref. pages 42 & 45
	*5200305260	CONTROL PCB ASSY [US]	Ref. pages 42 & 45
	*5200305270	CONTROL PCB ASSY [GE]	Ref. pages 42 & 45
	*5200305280	CONTROL PCB ASSY [E]	Ref. pages 42 & 45
	*5200305290	CONTROL PCB ASSY [UK]	Ref. pages 42 & 45
1-18	*5801341500	SPACER, TRANSFORMER	
1-19	*5801342300	HOLDER, VOLUME	
1-20	*5801341300	ROD, KNOB (C)	
1-21	*5801356800	ROD (N), VOLUME	
1-22	*5801362200	SPRING (2), EARTH	
1-23	*5801341600	ROD, VR	
1-24	*5801362100	SPRING (1), EARTH	
1-25	5801341200	KNOB, JOINT (TEAC)	
	5801356500	KNOB, JOINT (G) (ESOTERIC)	
1-26	*5200304610	R/P AMP PCB ASSY	Ref. pages 41 & 43
1-27	*5801342400	CHASSIS (A), SIDE	
1-28	*5200305010	FRONT PCB ASSY	Ref. pages 42 & 46
1-29	5801341100	KNOB C (B) (TEAC)	
	5801356400	KNOB C (G) (ESOTERIC)	
1-30	*5801338201	FRONT PANEL R (B) ASSY (TEAC)	
	*5801397000	FRONT PANEL R (E) ASSY (ESOTERIC)	
1-31	*5801341400	WINDOW, FL	
1-32	5801341000	KNOB (B), REVERSE MOOD (TEAC)	
	5801358400	KNOB (G), REVERSE MOOD (ESOTERIC)	
1-33	5801340900	KNOB, SELECTOR (TEAC)	
	5801357000	KNOB (G), SELECTOR (ESOTERIC)	
1-34	5801353600	CASSETTE RID (R) ASSY (TEAC)	
	5801357600	CASSETTE RID (RG) ASSY (ESOTERIC)	
1-35	5801340600	MASTER KNOB (B) ASSY (TEAC)	
	5801356200	MASTER KNOB (G) ASSY (ESOTERIC)	
1-36	*5801343100	INSULATOR ASSY	
1-37	*5801342500	PLATE, BOTTOM	
1-38	*5787060700	SPACER, PUSH PS-7	

Continued on page 31

Parts marked with \*require longer delivery time.

[J]: JAPAN [US]: U.S.A. [C]: CANADA  
[E]: EUROPE [GE]: GENERAL EXPORT

# R-9000

## EXPLODED VIEW - 2 (R-9000)

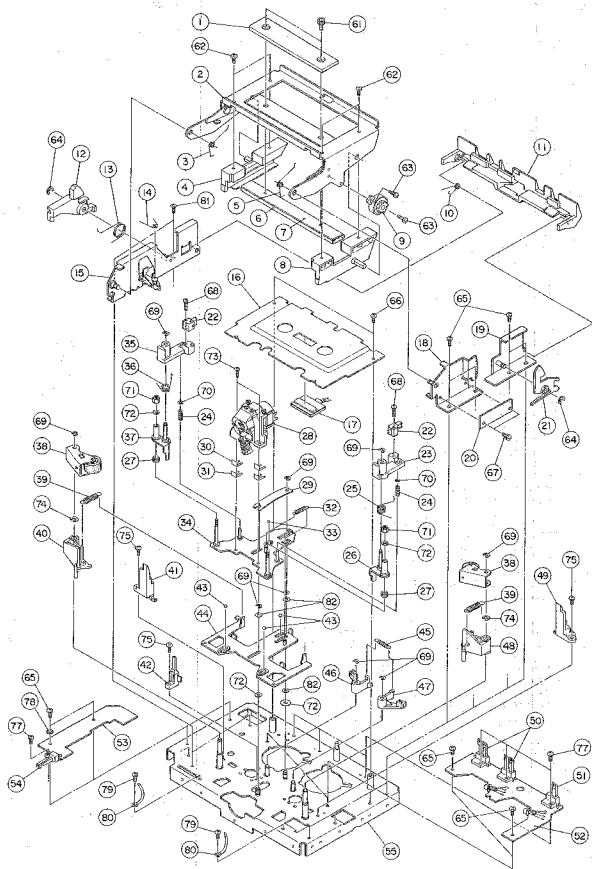

## EXPLODED VIEW-2 (R-9000)

REF. NO.	PARTS NO.	DESCRIPTION	REMARKS
2-1	*9801344400	PLATE, TOP (TEAC)	
	*9801357100	PLATE (G), TOP (ESOTERIC)	
2-2	*9801345900	CASSETTE HOLDER ASSY	
2-3	*9801344600	SPRING (L), HOLDER	
2-4	*9801344600	HOLDER (L)	
2-5	*9801344900	SPRING (R), HOLDER	
2-6	*9801344200	PAD (U) [1]	
	*9801363300	PAD (S) [EXCEPT J1]	
2-7	*9801343600	SPACER	
2-8	*9801344700	HOLDER (R)	
2-9	*9801354000	DAMPER, 1072-L	
2-10	*9800759800	SPRING, PRESS ARM	
2-11	*9800595602	ARM, SWITCH PRESS	
2-12	*9800768701	LEVER, CASSETTE LOCK	
2-13	*9800616300	SPRING, LOCK LEVER	
2-14	*9800616400	SPRING, EJECT PLATE PRESSURE	
2-15	*9801345600	SWITCH ARM BRACKET (L) ASSY	
2-16	*9801343701	PANEL, CASSETTE	
2-17	5229025500	LED, SLF60IC (ORG)	
2-18	*9801346100	HOLDER BRACKET PLATE ASSY	
2-19	*9801345400	BRACKET (R) ASSY	
2-20	*5210238100	JOINT PCB	
2-21	*9801344500	LEVER (R), LOCK	
2-22	5379095600	GUIDE, ERASE HEAD	
2-23	*9801343500	BASE (R), ERASE HEAD	
2-24	*9800615700	SPRING, ERASE HEAD GUIDE	
2-25	*9800615600	SPRING (R), ERASE HEAD ARM	
2-26	9800618800	ARM ASSY (R), ERASE HEAD	
2-27	*9800615300	SPRING, ERASE HEAD	
2-28	9801350300	HEAD HOLDER ASSY	
2-29	*9800595900	SPRING, PRESSURE	
2-30	*9800595000	SPACER (A), 0.1MM	
2-31	*9800595100	SPACER (B), 0.2MM	
2-32	*9801005700	SPRING, HEAD BASE	
2-33	9540055000	STEEL BALL 2	
2-34	*9800618101	HEAD BASE ASSY	
2-35	*9801343400	BASE (L), ERASE HEAD	
2-36	*9800615500	SPRING (L), ERASE HEAD ARM	
2-37	*9800618700	ERASE HEAD ARM SUB ASSY	
2-38	9800618900	PINCH ROLLER ARM ASSY	
2-39	9800759100	SPRING, PINCH ROLLER	
2-40	9800596700	ARM (L), PINCH ROLLER	
2-41	9800595701	GUIDE (L), CASSETTE	
2-42	5228009900	PHOTO SENSOR, 59027-4	
2-43	5540095000	STEEL BALL 3	
2-44	9800618202	SLIDER ASSY	
2-45	*9800616100	SPRING, BRAKE	
2-46	*9800620000	BRAKE ARM (L) ASSY	
2-47	*9800619900	BRAKE ARM (R) ASSY	
2-48	9800596800	ARM (R), PINCH ROLLER	
2-49	9800595801	GUIDE (R), CASSETTE	
2-50	5301754100	SWITCH, LEAF LSA-2125AUS	
2-51	5301754300	SWITCH, LEAF LSA-1125-7AUS	
2-52	*5200182400	SENSOR PCB ASSY	
2-53	*5210182900	JOINT PCB	
2-54	5301754200	SWITCH, LEAF LSC-1223-39AUS	
2-55		MECHANISM CHASSIS ASSY	

Ref. page 40

Ref. pages 40 & 43  
Ref. page 40

## EXPLODED VIEW-2 (R-9000)

REF. NO.	PARTS NO.	DESCRIPTION	REMARKS
2-61	*5781713003	SCREW, HEX CUP M3X3 (BLK N1)	
2-62	*5781162606	SCREW, B.T. #2 M2.6X6 (BLK N1)	
2-63	*5783032904	SCREW, BIND S-TITE M2X4	
2-64	*5786003000	WASHER, E-RING E-3 (J13)	
2-65	*5783002605	SCREW, PAN S-TITE M2.6X5	
2-66	*5780022605	SCREW, BIND M2.6X3 (BLK N1)	
2-67	*5783002605	SCREW, PAN S-TITE M2.6X5	
2-68	*5780022008	SCREW, BIND M2X8 (BLK N1)	
2-69	*5786002000	WASHER, E-RING E-2 (J15)	
2-70	*5785302400	WASHER, POLYSL. 2.1X5X0.25T	
2-71	*5781952600	NUT, NYLON M2.6	
2-72	*5785513000	WASHER, POLYSL. 3X6X0.5T	
2-73	*5780002006	SCREW, BIND M2X6	
2-74	*5786002500	WASHER, E-RING E-2.5 (J13)	
2-75	*5783032606	SCREW, BIND S-TITE M2.6X6	
2-76	*9800818500	WASHER, 19X3.2X0.2T	
2-77	*5783032005	SCREW, BIND S-TITE M2X5	
2-78	*5785122600	WASHER, LOCK (EXT.) 2.6	
2-79	*5783002004	SCREW, PAN S-TITE M2X4	
2-80	*5786710100	CLIP, HARNESS 2.3X4X23.5	
2-81	*5783032604	SCREW, BIND S-TITE M2.6X4	
2-82	*5785303100	WASHER, POLYSL. 3X6X0.25T	

Continued from page 29

## EXPLODED VIEW-1 (R-9000)

REF. NO.	PARTS NO.	DESCRIPTION	REMARKS
1-41	*5783763006	SCREW, BIND S-TITE M3X6 (CU)	
1-42	*5783753008	SCREW, BIND P-TITE M3X6 (CU)	
1-43	*5783033006	SCREW, BIND S-TITE M3X6	
1-44	Vacant		
1-45	*5783034022	SCREW, BIND S-TITE M4X22	
1-46	*5785012400	WASHER, FLAT 4.5X10X0.8T	
1-47	*5783073006	SCREW, CUP PAN S-TITE M3X6	
1-48	*5783723008	SCREW, BIND S-TITE M3X8 (CU)	
1-49	*5781263008	SCREW, FLAT TAP (#2) M3X8 (BLK N1)	
1-50	*5783034016	SCREW, BIND S-TITE M4X16	

EXPLODED VIEW - 3 (R-9000)

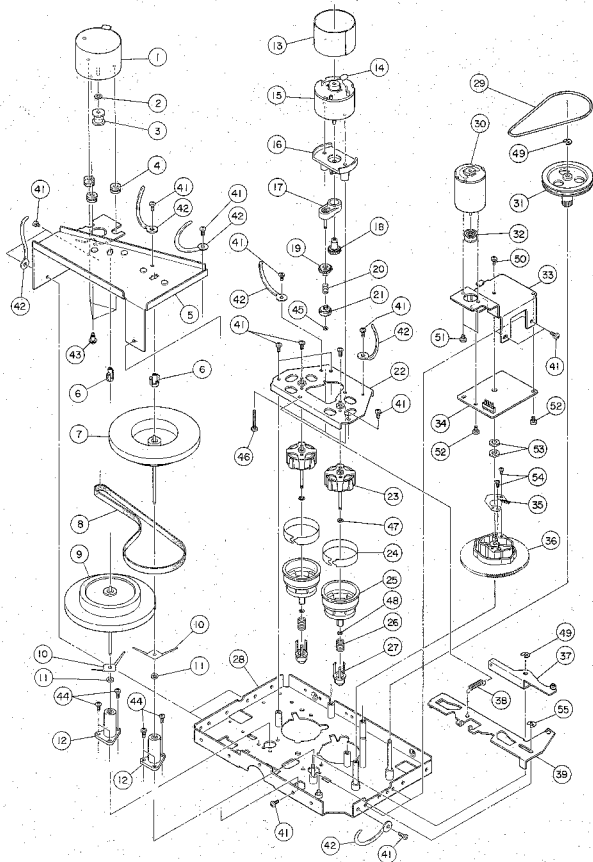

EXPLODED VIEW-3 (R-9000)

REF. NO.	PARTS NO.	DESCRIPTION	REMARKS
3-1	5370009500	MOTOR, DC CAPSTAN	
3-2	*9801008000	WASHER, OIL	
3-3	5801006500	PULLEY, CAPSTAN MOTOR	
3-4	5334537001	DAMPER	
3-5	*9800732000	BRACKET, FLYWHEEL	
3-6	*9801198100	SHAFT (F), THRUST	
3-7	9800732200	CAPSTAN ASSY (L)	
3-8	9534810000	BELT, CAPSTAN	
3-9	9800732300	CAPSTAN ASSY (R)	
3-10	*9801197900	SPRING (U), THRUST	
3-11	*9800729400	WASHER (A), TEFLON	
3-12	9800732100	METAL HOLDER ASSY	
3-13	*9800235900	PLATE, SEALED	
3-14	*5173395000	C., CERAMIC 0.047MF /50V	
3-15	5370002902	MOTOR, REEL DC .015 0.2	
3-16	*9800732603	HOLDER, MOTOR	
3-17	9800461500	PULLEY ARM ASSY	
3-18	9800736000	GEAR, PULLEY (A)	
3-19	9800461600	GEAR, PULLEY (B) ASSY	
3-20	*9800430200	SPRING, PULLEY	
3-21	9800430302	PULLEY IDLER ASSY	
3-22	*9800731600	BRACKET, REEL ASSY	
3-23	5347003300	COIL SHAFT ASSY	
3-24	*9800731400	RING, HYSTERESIS	
3-25	9800731501	REEL TABLE ASSY	
3-26	9800231300	SPRING, REEL	
3-27	9800236901	RING, DRIVE	
3-28	9800236901	MECHANISM CHASSIS ASSY	
3-29	9800419201	BELT, CAM CONTROL	
3-30	5370005100	MOTOR, DC RF-280R-10350	
3-31	9800597001	PULLEY, REDUCTION	
3-32	9800123301	PULLEY, V	
3-33	*9800732400	BRACKET, MOTOR	
3-34	*5210152401	CAM POS.	
3-35	*9800595300	PLATE, CONTACT	
3-36	9800597401	CAM, CONTROL	
3-37	*9800620701	BASE ARM ASSY	
3-38	*9800732500	SPRING, DIRECTION	
3-39	*9800620801	CHANGE LEVER ASSY	
3-41	*5783002605	SCREW, PAN S-TITE M2.6X5	
3-42	*9786713000	CLIP, HARNESS 3.0X9.1X50	
3-43	*9730033100	SCREW, WASHER HEAD M2.6X5-2	
3-44	*9783002606	SCREW, PAN S-TITE M2.6X5	
3-45	*9785331500	WASHER, POLYSL. 1.5X4X0.5T	
3-46	*9780002617	SCREW, BIND M2.6X17	
3-47	*9785301100	WASHER, POLYSL. 1.5X4X0.25T	
3-48	*9785331100	WASHER, POLYSL. 1.2X3.6X0.5T	
3-49	*9786002000	WASHER, E-RING E-2 (JIS)	
3-50	*9780002004	SCREW, BIND M2X4	
3-51	*9780002603	SCREW, BIND HEAD M2.6X3	
3-52	*9783032604	SCREW, BIND S-TITE M2.6X4	
3-53	*9785024800	WASHER, FLAT 4.3XBX0.8T	
3-54	*9781112004	SCREW, BIND TAP #2 M2X4	
3-55	*9786010900	WASHER, E-RING E-2 (E-9)	

Ref. page 40

Parts marked with \*require longer delivery time.

[J]: JAPAN [US]: U.S.A. [C]: CANADA  
[E]: EUROPE [GE]: GENERAL EXPORT



## INCLUDED ACCESSORIES (R-9000)

REF. NO.	PARTS NO.	DESCRIPTION	REMARKS
	*5700118600	OWNER'S MANUAL [J]	
	*5700119300	OWNER'S MANUAL [US]	
	*5700118700	OWNER'S MANUAL [EXCEPT J,US]	
	*5744077300	REMOTE CONTROL UNIT ; RC-366	
	*5350015700	CORD, IN-OUT (RCA-RCA)	
	*5347006900	BATTERY [J]	
	*5347007000	BATTERY [EXCEPT J]	

Parts marked with \*require longer delivery time.

[J]: JAPAN [US]: U.S.A. [C]: CANADA  
 [E]: EUROPE [GE]: GENERAL EXPORT

# V-9000

## EXPLODED VIEW - 4 (V-9000)

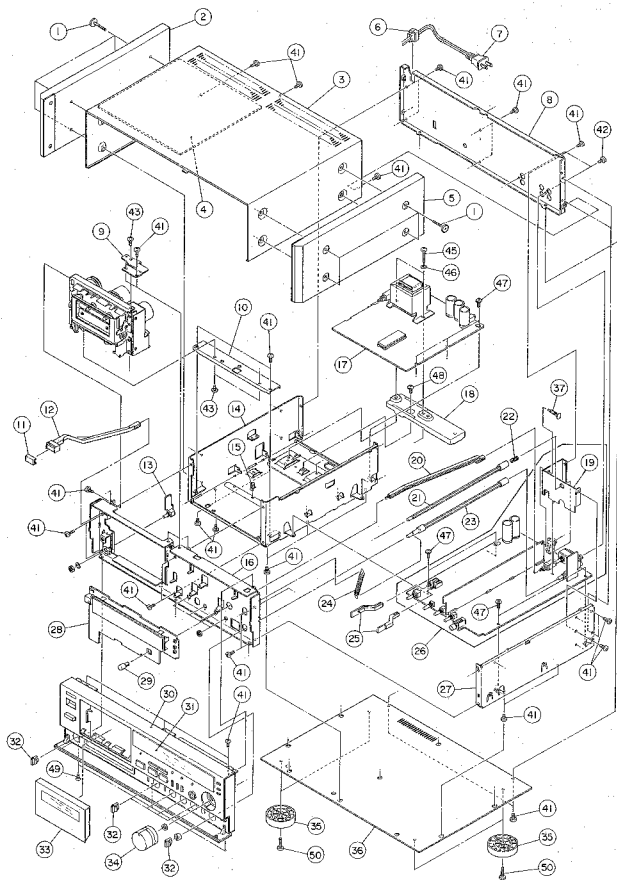

## EXPLODED VIEW-4 (V-9000)

REF. NO.	PARTS NO.	DESCRIPTION	REMARKS
4- 1	*5800954700	SCREW ASSY, SIDE BOARD	
4- 2	*5801353400	BOARD (L), SIDE	
4- 3	*5801342800	BONNET (G)	
4- 4	*5801145700	SHEET (C), DUMPER	
4- 5	*5801353500	BOARD (R), SIDE	
4- 6	*5317003400	BUSHING 2271	
4- 7	Δ*5350015600	CORD, AC [J]	
	Δ*5350010700	CORD, AC [US,C,GE] UL SPT-2	
	Δ*5350011700	CORD, AC [E] CEE CLASS-2	
	Δ*5128047000	CORD, AC [UK] BS	
	Δ*5350008300	CORD, AC [AUS] ASS	
4- 8	*5801342600	PANEL, REAR [EXCEPT GE]	
	*5801353300	PANEL, REAR [GE]	
4- 9	*5801342100	HOLDER, MECHANISM (UPPER)	
4-10	*5801342200	HOLDER, MECHANISM (UNDER)	
4-11	5801356100	CUP (G), POWER (TEAC/ESOTERIC)	
	5801340500	CUP (B), POWER (TEAC)	
4-12	*5801340400	JOINT, POWER	
4-13	*5200305100	SWITCH PCB ASSY	Ref. pages 40 & 47
4-14	*5801343000	CHASSIS, MAIN	
4-15	*5787060700	SPACER, PUSH PS-7 A=11.11	
4-16	*5801342900	CHASSIS, FRONT	
4-17	*5200305200	CONTROL PCB ASSY [J]	Ref. pages 42 & 49
	*5200305210	CONTROL PCB ASSY [US]	Ref. pages 42 & 49
	*5200305220	CONTROL PCB ASSY [GE]	Ref. pages 42 & 49
	*5200305230	CONTROL PCB ASSY [E]	Ref. pages 42 & 49
	*5200305240	CONTROL PCB ASSY [UK]	Ref. pages 42 & 49
4-18	*5801341500	SPACER, TRANSFORMER	
4-19	*5801342300	HOLDER, VOLUME	
4-20	*5801341300	ROD, KNOB (C)	
4-21	*5801356800	ROD (N), VR	
4-22	*5801362200	SPRING (2), EARTH	
4-23	*5801341600	ROD, VR	
4-24	*5801362100	SPRING (1), EARTH	
4-25	5801356900	KNOB (G), JOINT (TEAC/ESOTERIC)	
	5801341200	KNOB (B), JOINT (TEAC)	
4-26	*5200304600	R/P AMP PCB ASSY	Ref. pages 41 & 47
4-27	*5801342400	SHASSIS (A), SIDE	
4-28	*5200305000	FRONT PCB ASSY	Ref. pages 42 & 50
4-29	5801356400	KNOB C (G) (TEAC/ESOTERIC)	
	5801341100	KNOB C (B) (TEAC)	
4-30	5801354801	FRONT PANEL V (G) ASSY (TEAC)	
	5801338101	FRONT PANEL V (B) ASSY (TEAC)	
	5801396900	FRONT PANEL V (E) ASSY (ESOTERIC)	
4-31	*5801341400	WINDOW, FL	
4-32	5801357000	KNOB (G), SELECTOR (TEAC/ESOTERIC)	
	5801340900	KNOB (B), SELECTOR (TEAC)	
4-33	5801343800	CASSETTE RID (VBL) ASSY (TEAC)	
	5801357200	CASSETTE RID (VG) ASSY (TEAC/ESOTERIC)	
4-34	5801356200	MASTER KNOB (G) ASSY (TEAC/ESOTERIC)	
	5801340600	MASTER KNOB (B) ASSY (TEAC)	
4-35	*5801343100	INSULATOR ASSY	
4-36	*5801342500	PLATE, BOTTOM	
4-37	*5787060700	SPACER, PUSH PS-7	

Continued on page 37

Parts marked with \*require longer delivery time.

[J]:JAPAN [US]:U.S.A. [C]:CANADA  
[E]:EUROPE [GE]:GENERAL EXPORT

# V-9000

## EXPLODED VIEW - 5(V-9000)

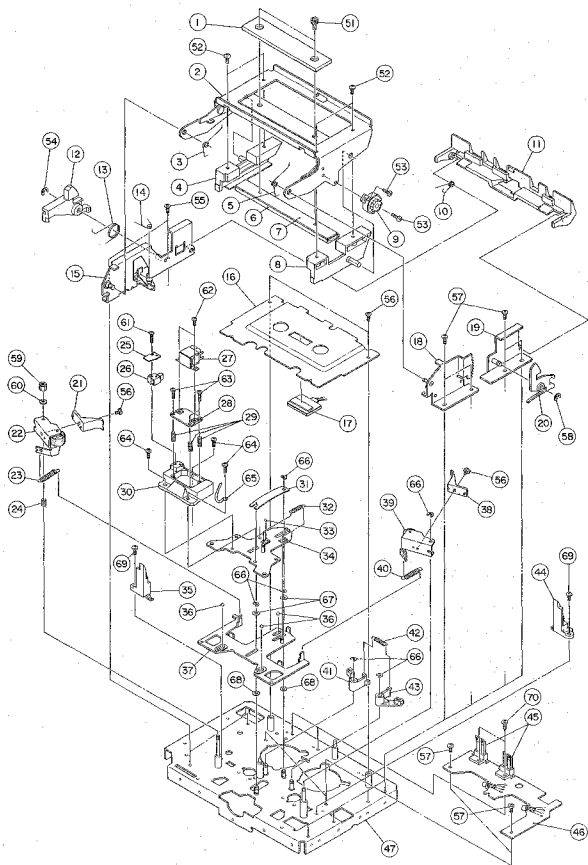

## EXPLODED VIEW-5 (V-9000)

REF. NO.	PARTS NO.	DESCRIPTION	REMARKS
5-1	*5801344400	PLATE, TOP (BL) (TEAC)	
	*5801357100	PLATE, TOP (G) (TEAC/ESOTERIC)	
5-2	*5801345000	CASSETTE HOLDER ASSY	
5-3	*5801344800	SPRING (L), HOLDER	
5-4	*5801344600	HOLDER (L)	
5-5	*5801344900	SPRING (R), HOLDER	
5-6	*5801344200	PAD (U) (J)	
	*5801365300	PAD (S) (EXCEPT J)	
5-7	*5801343600	SPACER	
5-8	5801344700	HOLDER (R)	
5-9	5801354000	DUMPER, 1C72-L	
5-10	*5800795800	SPRING, PRESS ARM	
5-11	*5800959602	ARM, SWITCH PRESS	
5-12	*5800768701	LEVER, CASSETTE LOCK	
5-13	*5800618300	SPRING, CASSETTE LOCK LEVER	
5-14	*5800516400	SPRING, EJECT PLATE PRESSURE	
5-15	*5801345600	SWITCH ARM BRACKET (L) ASSY	
5-16	*5801345701	PANEL, CASSETTE	
5-17	5225029500	LED, SUB601C (ORG)	
5-18	*5801346100	HOLDER BRACKET PLATE ASSY	
5-19	*5801345400	BRACKET (R) ASSY	
5-20	*5801344500	LEVER (R), LOCK	
5-21	5800956000	GUIDE, TAPE	
5-22	5800955200	PINCH ROLLER ARM ASSY (L)	
5-23	*5800959700	SPRING (L), PINCH ROLLER	
5-24	*5800418400	SPRING, PINCH ROLLER ARM	
5-25	*5800959100	COVER, ERASE HEAD	
5-26	5378905500	HEAD, ERASE	
5-27	5378905800	HEAD, REC./PLAY	
5-28	*5801345900	PLATE, HEAD	
5-29	*5800931300	SPRING, HEAD	
5-30	*5800959900	BRACKET, HEAD	
5-31	*5800959500	SPRING, PRESSURE	
5-32	*5801005700	SPRING, HEAD BASE	
5-33	5540095000	STEEL BALL, 2	
5-34	*5800957200	HEAD BASE ASSY	
5-35	5800959701	GUIDE (L), CASSETTE	
5-36	5540095600	STEEL BALL, 3	
5-37	5800618202	SLIDER ASSY	
5-38	*5801346000	T. COMP.	
5-39	5800959400	PINCH ROLLER ARM ASSY (R)	
5-40	5800959800	SPRING (R), PINCH ROLLER	
5-41	*5800620000	BRAKE ARM (L) ASSY	
5-42	*5800737200	SPRING, LOCK	
5-43	*5800619900	BRAKE ARM (R) ASSY	
5-44	5800959801	GUIDE (R), CASSETTE	
5-45	5301754100	SWITCH, LEAF LSA-2125AUS	
5-46	*5200182400	SENSOR PCB ASSY	
5-47		MECHANISM CHASSIS ASSY	

Ref. pages 40 &amp; 47

## EXPLODED VIEW-5 (V-9000)

REF. NO.	PARTS NO.	DESCRIPTION	REMARKS
5-51	*5781713003	SCREW, HEX CUP M3X3 (BLK N1)	
5-52	*5781162606	SCREW, B.T.#2 M2.6X5 (BLK N1)	
5-53	*5783032004	SCREW, BIND S-TITE M2X4	
5-54	*5786003000	WASHER, E-RING E-3 (JIS)	
5-55	*5783032604	SCREW, BIND S-TITE M2.6X4	
5-56	*5780022605	SCREW, BIND M2.6X5 (BLK N1)	
5-57	*5783002605	SCREW, PAN S-TITE M2.6X5	
5-58	*5786003000	WASHER, E-RING E-3 (JIS)	
5-59	*5781952600	NUT, NAYLON M2.6	
5-60	*5800978900	WASHER, 2.9X5X0.8T	
5-61	*5780022008	SCREW, BIND M2X8 (BLK N1)	
5-62	*5782422004	SCREW, PAN #1 2X4 (N1)	
5-63	*5780112008	SCREW, PAN HEAD M2X8 (N1)	
5-64	*5780002005	SCREW, BIND M2X5	
5-65	*5786710300	CLIP, HARNESS 2X4.5X42	
5-66	*5786002000	WASHER, E-RING E-2 (JIS)	
5-67	*5785303100	WASHER, POLYSL. 3X6X0.25T	
5-68	*5785313000	WASHER, POLYSL. 3X6X0.5T	
5-69	*5783032606	SCREW, BIND S-TITE M2.6X6	
5-70	*5783032005	SCREW, BIND S-TITE M2X5	

Continued from page 35

## EXPLODED VIEW-4 (V-9000)

REF. NO.	PARTS NO.	DESCRIPTION	REMARKS
4-41	*5783763006	SCREW, BIND B-TITE M3X6 (CU)	
4-42	*5783793008	SCREW, BIND P-TITE M3X8 (CU)	
4-43	*5783033006	SCREW, BIND S-TITE M3X6	
4-44	Vacant		
4-45	*5783034022	SCREW, BIND S-TITE M4X22	
4-46	*5789012400	WASHER, FLAT 4.5X10X0.8T	
4-47	*5783073006	SCREW, CUP PAN S-TITE M3X6	
4-48	*5783723008	SCREW, BIND B-TITE M3X8	
4-49	*5781263008	SCREW, FLAT TAP (#2) M3X8 (BLK N1)	
4-50	*5783034016	SCREW, BIND S-TITE M4X16	

[J]:JAPAN [U]:U.S.A. [C]:CANADA  
[E]:EUROPE [G]:GENERAL EXPORT

Parts marked with \*require longer delivery time.

[J]:JAPAN [U]:U.S.A. [C]:CANADA  
[E]:EUROPE [G]:GENERAL EXPORT

## EXPLODED VIEW - 6(V-9000)

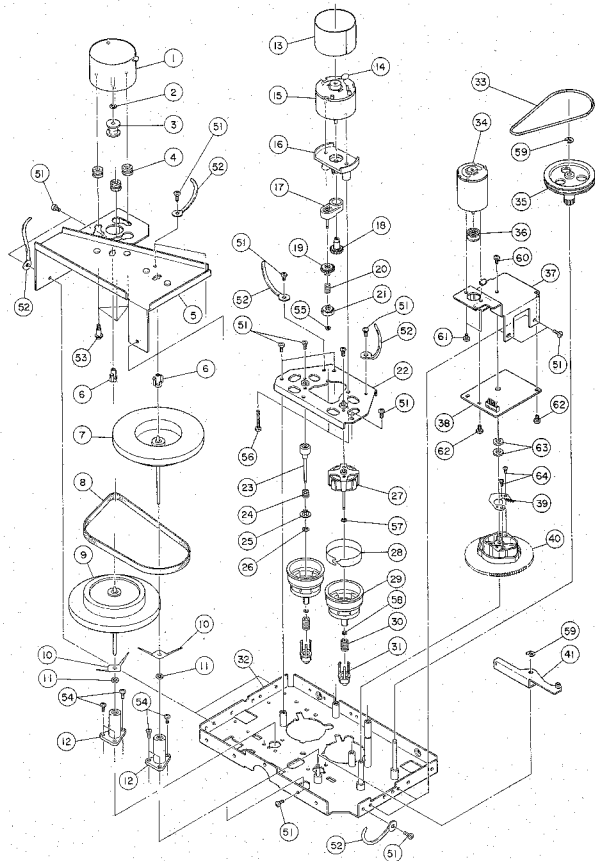

## EXPLODED VIEW-6 (V-9000)

REF. NO.	PARTS NO.	DESCRIPTION	REMARKS
6-1	5370007800	MOTOR, CAPSTAN DC SHL.2L	
6-2	*9801008000	WASHER, OIL	
6-3	9801006500	PULLEY, CM	
6-4	5534537001	DAMPER	
6-5	*9800996200	BRACKET, FLYWHEEL	
6-6	*9801198100	CHAFT (F), THRUST	
6-7	9800732200	CAPSTAN ASSY (L)	
6-8	5534510000	BELT, CAPSTAN	
6-9	9800732300	CAPSTAN ASSY (R)	
6-10	*9801197900	SPRING (U), THRUST	
6-11	*9800729400	WASHER (A), TEFLON	
6-12	9800732100	METAL HOLDER ASSY	
6-13	*9800235900	PLATE, SEALED	
6-14	*5173395000	C., CERAMIC 0.047ME/50V	
6-15	5370002502	MOTOR, REEL DC .015 0.2	
6-16	*9800732603	HOLDER, MOTOR	
6-17	9800461500	PULLEY ARM ASSY	
6-18	9800736000	GEAR, PULLEY (A)	
6-19	9800461600	GEAR PULLEY (B) ASSY	
6-20	9800430200	SPRING, PULLEY	
6-21	*9800430302	IDLER ASSY	
6-22	*9800731600	BRACKET, REEL ASSY	
6-23	*9800917400	REEL SHAFT ASSY	
6-24	*9800481901	SPRING, B. TENSION	
6-25	*9800231500	HOLDER, SPRING	
6-26	*9800539800	WASHER, TEFLON 1.7X4X0.3T	
6-27	*5347003300	COIL SHAFT ASSY	
6-28	*9800731400	RING, HYSTERESIS	
6-29	9800731501	REEL TABLE ASSY	
6-30	*9800231300	SPRING, REEL	
6-31	9800236501	RING, DRIVE	
6-32		MECHANISM CHASSIS ASSY	
6-33	9800419201	BELT, CAM CONTROL	
6-34	5370005100	MOTOR, DC RF-280R-10350	
6-35	9800597601	PULLEY, REDUCTION	
6-36	9800123301	PULLEY, V	
6-37	*9800732400	BRACKET, MOTOR	
6-38	*5210152401	CAM PCB	
6-39	9800595300	PLATE, CONTACT	
6-40	9800597401	CAM, CONTROL	
6-41	*9800620701	BASE ARM ASSY	

Ref. pages 40

## EXPLODED VIEW-6 (V-9000)

REF. NO.	PARTS NO.	DESCRIPTION	REMARKS
6-51	*5783002605	SCREW, PAN S-TITE M2.6X5	
6-52	*5786713000	CLIP, HARNESS 3.0X9.1X50	
6-53	*5730033100	SCREW, WASHER HEAD M2.6X9-2	
6-54	*5783002606	SCREW, PAN S-TITE M2.6X5	
6-55	*5785331500	WASHER, POLYSL. 1.5X4X0.5T	
6-56	*5780002617	SCREW, BIND M2.6X17	
6-57	*5785301100	WASHER, POLYSL. 1.5X4X0.25T	
6-58	*5785331100	WASHER, POLYSL. 1.2X3.6X0.5T	
6-59	*5786002000	WASHER, E-RING E-2 (JIS)	
6-60	*5780002004	SCREW, BIND M2X4	
6-61	*5780002603	SCREW, BIND HEAD M2.6X3	
6-62	*5783032604	SCREW, BIND S-TITE M2.6X4	
6-63	*5785024800	WASHER, FLAT 4.3X8X0.8T	
6-64	*5781112004	SCREW, B.TAPP.#2 M2X4	

## INCLUDED ACCESSORIES (V-9000)

REF. NO.	PARTS NO.	DESCRIPTION	REMARKS
	*5700118600	OWNER'S MANUAL [J]	
	*5700119300	OWNER'S MANUAL [US]	
	*5700118700	OWNER'S MANUAL [EXCEPT J,US]	
	*5744077200	REMOTE CONTROL UNIT ; RC-365	
	*5350015700	CORD, IN-OUT (RCA-RCA)	
	*5347006900	BATTERY [J]	
	*5347007000	BATTERY [EXCEPT J]	

Parts marked with \*require longer delivery time.

[J]:JAPAN [US]:U.S.A. [C]:CANADA  
[E]:EUROPE [GE]:GENERAL EXPORT

## 8 PC BOARDS AND PARTS LIST

基板図とパーツ・リスト

SENSOR PCB

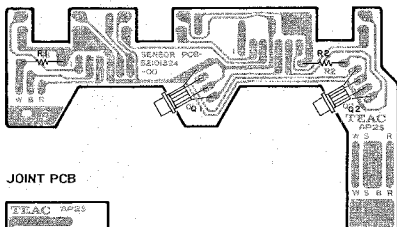

JOINT PCB

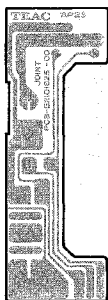

CAM PCB

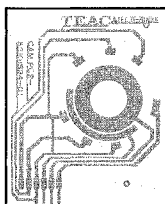

SW PCB



JOINT PCB





R/P AMP PCB

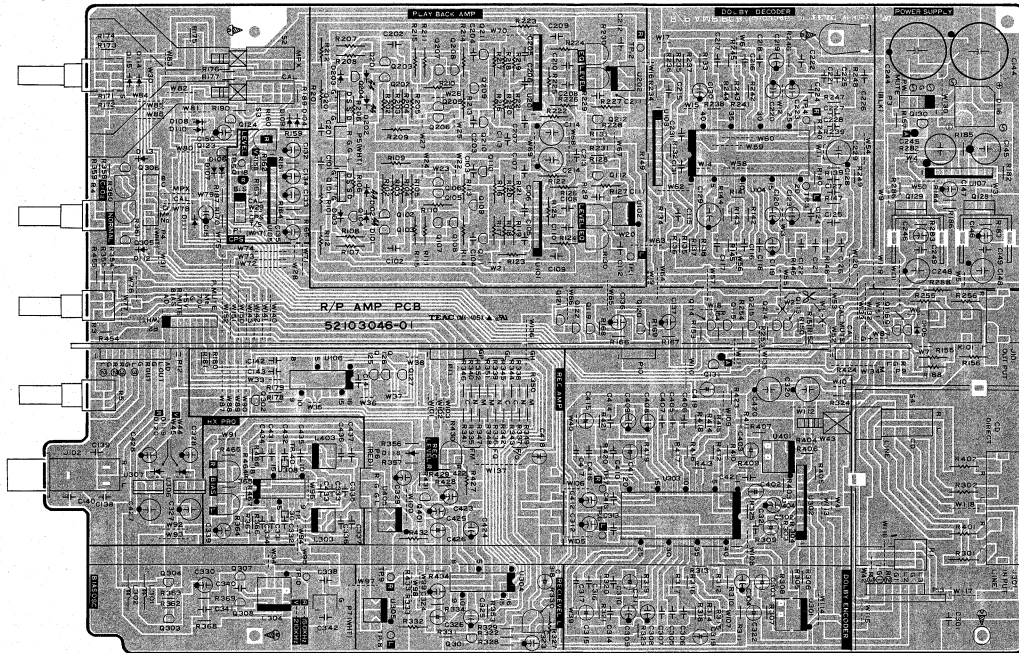

R/P SUB PCB

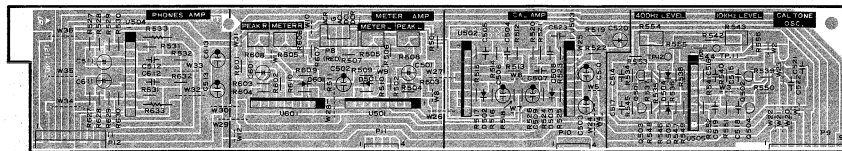

VR PCB

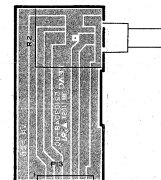

CONTROL PCB

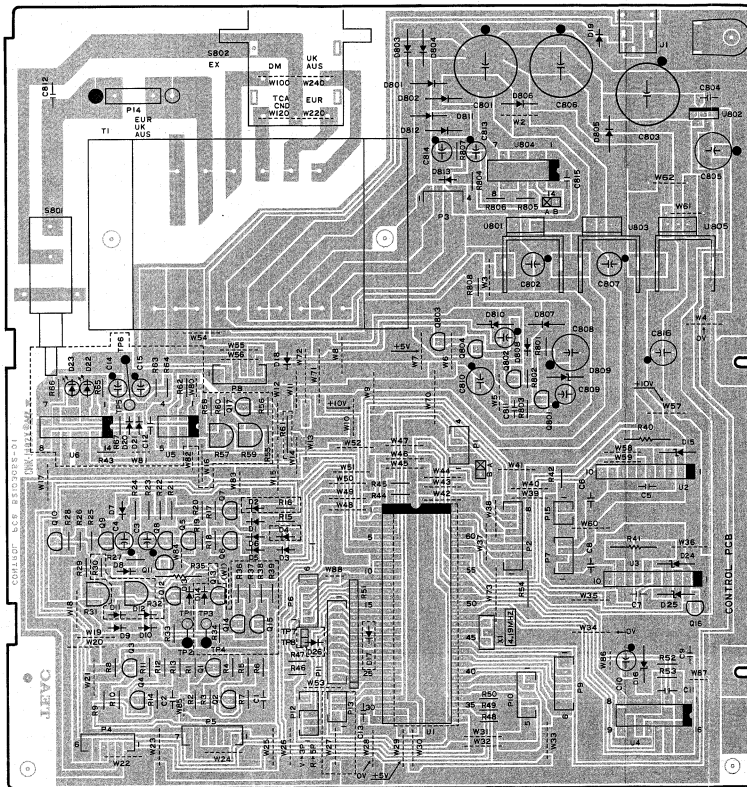

FRONT PCB

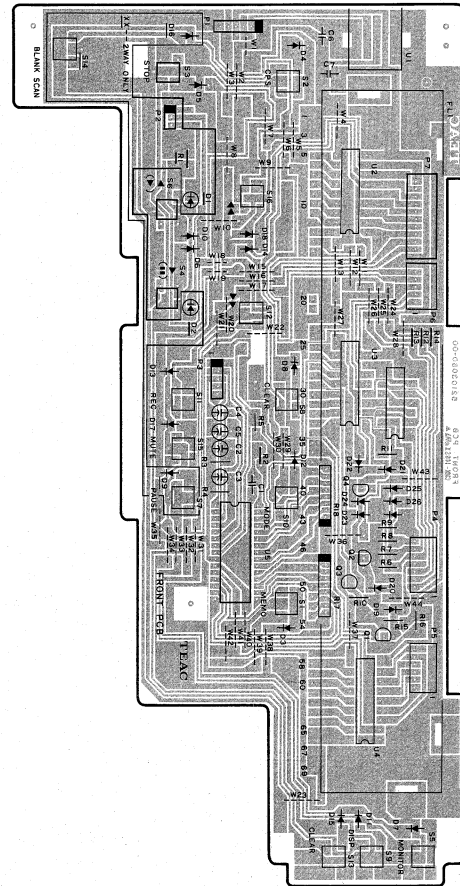

## SENSOR PCB ASSY (R-9000)

REF.NO.	PARTS NO.	DESCRIPTION
	*5200182400	SENSOR PCB ASSY
	*5210182400	SENSOR PCB
	9800735900	SPACER
Q001,002	5228013100	PHOTO REFLEC., NJL5141EA-B

## SWITCH PCB ASSY (R-9000)

REF.NO.	PARTS NO.	DESCRIPTION
	*5200305110	SWITCH PCB ASSY (R9000)
	*5210305100	SWITCH PCB
D001,002	5224015020	DIODE, 1SS133T-77
S001	5301206700	SWITCH, ROTARY SRBM15 L=15 F=04
S002	5301206800	SWITCH, ROTARY SRBM15 L=20 F=10

## R/P AMP PCB ASSY (R-9000)

REF.NO.	PARTS NO.	DESCRIPTION
	*5200304610	R/P AMP PCB ASSY
	*5210304601	R/P AMP PCB
	5555900000	PLATE (A), EARTH P.C.BOARD
	9800990100	HEAT SINK
C101,201	5263301120	C., POLY. 150PF/100V J VT
C102,202	5263301520	C., POLY. 330PF/100V J VT
C106,206	5263291820	C., POLY. 0.047UF/100V J VT
C107,207	5263302120	C., POLY. 6800PF/63V J VT
C108,208	5263301720	C., POLY. 1500PF/100V J VT
C109,209	5263293520	C., POLY. 1.0UF/63V J VT
C110,210	5263293520	C., POLY. 1.0UF/63V J VT
C111,211	5263291320	C., POLY. 0.018UF/100V J VT
C112,212	5263302020	C., POLY. 4700PF/63V J VT
C113,213	5263291420	C., POLY. 0.022UF/100V J VT
C114,214	5260473320	C., ELEC. 100UF/16V M PZ VT
C115,215	5263293520	C., POLY. 1.0UF/63V J VT
C121,221	5263166923	C., METAL 0.015MF/50V J VT
C122,222	5263293520	C., POLY. 1.0UF/63V J VT
C124,224	5263167723	C., METAL 0.068UF/50V J VT
C125,225	5263167623	C., METAL 0.056UF/50V J VT
C126,226	5263293520	C., POLY. 1.0UF/63V J VT
C128,228	5263166723	C., METAL 0.010UF/50V J VT
C129,229	5260473320	C., ELEC. 100UF/16V M PZ VT
C131,231	5263291420	C., POLY. 0.022UF/100V J VT
C144,244	Δ5260476910	C., ELEC. 3300UF/25V M PZ VF
C145,245	Δ5260474010	C., ELEC. 220UF/25V M PZ VF
C148,248	5260473320	C., ELEC. 100UF/16V M PZ VT
C149,249	5263291420	C., POLY. 0.022UF/100V J VT
C302,402	5260480620	C., ELEC. 1UF/50V M PZBP VT

## R/P AMP PCB ASSY (R-9000)

REF.NO.	PARTS NO.	DESCRIPTION
C303,403	5260480620	C., ELEC. 1UF/50V M PZBP VT
C310,410	5263166923	C., METAL 0.015MF/50V J VT
C311,411	5260480620	C., ELEC. 1UF/50V M PZBP VT
C313,413	5263167723	C., METAL 0.068UF/50V J VT
C314,414	5263167623	C., METAL 0.056UF/50V J VT
C315,415	5260480620	C., ELEC. 1UF/50V M PZBP VT
C317,417	5263166723	C., ELEC. 0.010UF/50V J VT
C318 C418	5260481220	C., ELEC. 10UF 16V M PZBP VT
C319 C419	5260481220	C., ELEC. 10UF 16V M PZBP VT
C320,420	5260473320	C., ELEC. 100UF/16V M PZ VT
C322	5260480620	C., ELEC. 1UF 50V M PZBP VT
C324,424	5260472620	C., ELEC. 47UF/10V M PZ VT
C326 C426	5260481220	C., ELEC. 10UF 16V M PZBP VT
C327,427	5260473220	C., ELEC. 100UF/10V M PZ VT
C331,431	5263166723	C., METAL 0.010UF/50V J VT
C332,432	5263167523	C., METAL 0.047MF/50V J VT
C333,433	5263167123	C., METAL 0.022UF/50V J VT
C334,434	5263107220	C., POLY. 5600PF/100V J VT
C335,435	5263167523	C., METAL 0.047MF/50V J VT
C336,436	5263106420	C., POLY. 270PF/100V J
C337,437	5263105420	C., POLY. 100PF/100V J VT
C340	5263167123	C., METAL, 0.022UF/50V J VT
C342	5263101320	C., POLY. 0.0022UF/100V J VT
D101,201	5225015820	LED., LTZ-MR15
D102,D202	5225015820	LED., LTZ-MR15
D103-115	5224015020	DIODE, 1SS133T-77
D116	Δ5228010800	SILICON STACK, 52VB10 Y870
D118-120	5224015020	DIODE, 1SS133T-77
D203	5224015020	DIODE, 1SS133T-77
J101	5330510700	JACK, PIN 2P
J102	5330014700	JACK, PIN 3P FJ332DAB-MA
J301	5330510600	JACK, PIN 4P
K101	5290013800	RELAY, DF2-DC12V
L301,302	5286031000	COIL, CHOKE 220UH LAL04KB
L303,403	5286038400	COIL, STEP-UP 210K
L304	5286038600	COIL, OSC 210KHZ
P4	5336249700	CONN., PLUG B07B-PH-K-5 WHT
P5	5336303400	CONN., PLUG B4B-EH WHT
P6	5336305400	CONN., PLUG B4B-EH-R RED
P7	5336303200	CONN., PLUG B2B-EH WIT
Q101,201	5232008600	FET., 2SK389BL
Q102-104	5230770100	TRANSISTOR 2SC2240BL
Q105,205	5145162000	TRANSISTOR 2SA-970BL
Q106,206	5145162000	TRANSISTOR 2SA-970BL
Q107-110	5230770100	TRANSISTOR 2SC2240BL
Q111,211	5145162000	TRANSISTOR 2SA-970BL
Q112,212	5230780920	TRANSISTOR 2SC2603F
Q113	5232008420	FET., 2SK381D
Q114,214	5232008420	FET., 2SK381D
Q115,215	5232008420	FET., 2SK381D
Q116	5232255720	TR., DIGITAL DTC124ES
Q117,119	5232254820	TR., DIGITAL DTA124ES
Q118	5232255720	TR., DIGITAL DTC124ES
Q120,123	5232254820	TR., DIGITAL DTA124ES
Q121,122	5232255720	TR., DIGITAL DTC124ES

Parts marked with \*require longer delivery time.

[J]:JAPAN [US]:U.S.A. [C]:CANADA  
[E]:EUROPE [GE]:GENERAL EXPORT

# R-9000

## R/P AMP PCB ASSY (R-9000)

REF. NO.	PARTS NO.	DESCRIPTION
Q124, 130	5232255720	TR., DIGITAL DTC124ES
Q125-127	5232254820	TR., DIGITAL DTA124ES
Q128	Δ5231762800	TRANSISTOR 25D1913R
Q129	Δ5230509700	TRANSISTOR 25B1274R
Q131	5232254820	TR., DIGITAL DTA124ES
Q202-204	5230770100	TRANSISTOR 25C2240BL
Q207-210	5230770100	TRANSISTOR 25C2240BL
Q301, 401	5231762020	TRANSISTOR 25D1450S/T
Q302	5232254820	TR., DIGITAL DTA124ES
Q303	5145085000	TRANSISTOR 25A-934R
Q304-306	5232255720	TR., DIGITAL DTC124ES
Q307, 308	5230780920	TRANSISTOR 25C2603F
R1	5282416600	VOLUME, 1S2U RK097 100KMN CC L=20
R3	5282416800	VOLUME, 1S2U RK097 20KBX2 CC L=20
R4	5282022400	VOLUME, 1S1U RK097 5KB CC L=20
R5	5282416700	VOLUME, 1S2U RK097 20KAX2 L=20
R101, 201	5240571720	R., ERDAIT 47K J
R102, 202	5240567720	R., ERDAIT 1.0K J
R103, 203	5240569320	R., ERDAIT 4.7K J
R104, 204	5240567720	R., ERDAIT 1.0K J
R105, 205	5240564920	R., ERDAIT 68K J
R106, 206	5240568120	R., ERDAIT 1.5K J
R107, 207	5240566520	R., ERDAIT 330 J
R108, 208	5240566520	R., ERDAIT 330 J
R109, 209	5240567520	R., ERDAIT 820 J
R110, 210	5240570120	R., ERDAIT 10K J
R111, 211	5240567920	R., ERDAIT 1.2K J
R112, 212	5240564120	R., ERDAIT 33 J
R113, 213	5240568720	R., ERDAIT 2.7K J
R114, 214	5240568320	R., ERDAIT 1.8K J
R115, 215	5240567920	R., ERDAIT 1.2K J
R116, 216	5240564120	R., ERDAIT 33 J
R117, 217	5240564120	R., ERDAIT 33 J
R118, 218	5240572120	R., ERDAIT 68K J
R119, 219	5240568720	R., ERDAIT 2.7K J
R120, 220	5240567820	R., ERDAIT 1.1K J
R121, 221	5240569220	R., ERDAIT 4.3K J
R122, 222	5240569420	R., ERDAIT 5.1K J
R123, 223	5240569520	R., ERDAIT 5.6K J
R124, 224	5240572920	R., ERDAIT 150K J
R125, 225	5240572920	R., ERDAIT 150K J
R126, 226	5240568720	R., ERDAIT 2.7K J
R127, 227	5240568720	R., ERDAIT 2.7K J
R129, 229	5280021300	R., TRIMMER 10KB H.
R130, 230	5280021700	R., TRIMMER, 47KB H.
R155, 255	5240569320	R., ERDAIT 4.7K J
R156, 256	5240566920	R., ERDAIT 470 J
R160	5280021700	R., TRIMMER, 47KB H.
R184	5241461020	R., METAL 15K F
R185	5241459420	R., METAL 3.3K F
R186, 286	5241461020	R., METAL 15K F
R188, 288	5240566920	R., ERDAIT 470 J
R301, 401	5240570720	R., ERDAIT 18K J

## R/P AMP PCB ASSY (R-9000)

REF. NO.	PARTS NO.	DESCRIPTION
R302, 402	5240570720	R., ERDAIT 18K J
R327, 427	5240570120	R., ERDAIT 10K J
R330, 430	5280021300	R., TRIMMER 10KB H.
R332, R432	5240568320	R., ERDAIT 1.8K J
R360	5280021500	R., TRIMMER 22KB H.
R361	5280021300	R., TRIMMER 10KB H.
R364, 464	5280021300	R., TRIMMER 10KB H.
S1	5301206800	SWITCH, ROTARY SR8M13 L=20 F=10
S2, 3	5300054600	SWITCH, PUSH SPUL 2-2 NS
S4	5300054500	SWITCH, PUSH SPUL 2-2 NS
TPI-10	5317002100	PIN, OH CHECK IPS-1136
U101, 201	5220439500	IC., UPC4570HA
U102, 202	5286038800	COIL, TRAP 210KHZ
U103, 302	5220439500	IC., UPC4570HA
U104, 303	5220443500	IC., CX20188
U105	5220426200	IC., M51143AL
U106	5220092400	IC., DIGITAL BU4052B
U107	5220425800	IC., M5230LA
U301, 401	5292805600	FILTER, LOWPASS MPX
U304	5220439700	IC., CXA1198AP
U305, 405	5286038800	COIL, TRAP 210KHZ
U306	5220434500	IC., M5F7807L
U307	5220435400	IC., M5F7907L
U308	5220430400	IC., UPC1297CA,
[J]: JAPAN	[US]: U.S.A.	[C]: CANADA
[E]: EUROPE	[GE]: GENERAL EXPORT	

Parts marked with \*require longer delivery time.

## R/P SUB PCB ASSY (R-9000)

REF. NO.	PARTS NO.	DESCRIPTION
	*5200304700	R/P SUB PCB ASSY
	*5210304700	R/P SUB PCB
C501,601	5260481220	C., ELEC. 100UF/16V M PZBP
C502	5260461520	C., ELEC. 100UF/25V M AU
C503	5260462620	C., ELEC. 47UF/16V M AU
C504	5263166923	C., METAL 0.015MF/50V J
C506	5260463020	C., ELEC. 100UF/10V M AU
C509	5260463020	C., ELEC. 100UF/10V M AU
C510	5260462620	C., ELEC. 47UF/16V M AU
C511,611	5260480620	C., ELEC. 1UF/50V M PZBP
C512,612	5263167923	C., METAL 0.1MF/50V J
C513,613	5260472720	C., ELEC. 47UF/16V M PZ
C514,517	5263166723	C., METAL 0.010UF/50V J
C518,519	5263167223	C., METAL 0.027UF/50V J
C520	5260481220	C., ELEC. 100UF/16V M PZBP
D501-D505	5224015020	DIODE, ISS133T-77
D601	5224015020	DIODE, ISS133T-77
F8	5336291500	CONN., PLUG. 55B-PH-K-R RED
P9	5336156900	CONN., PLUG. 9P
P10	5336156400	CONN., PLUG. 4P
P11	5336156400	CONN., PLUG. 4P
P12	5336302100	CONN., PLUG. 11P 9059
Q501,Q503	5232008420	FET., 2SK381D
Q502,Q504	5230780920	TRANSISTOR 2SC2603F
R505,605	5280036300	R., TRIMMER 10KB
R508,608	5280036700	R., TRIMMER 47KB
R533,633	5240563920	R., 27 J ERDAIT
R543,554	5280036300	R., TRIMMER 10KB
TP11-12	5317002100	PIN, DH CHECK IPS-1136
U501-U503	5220439500	IC., UPC4570HA
U504	5220438700	IC., LA6510
U505,U601	5220439500	IC., UPC4570HA

## VR PCB ASSY (R-9000)

REF. NO.	PARTS NO.	DESCRIPTION
	*5200304800	VR PCB SSY
	*5210304800	VR PCB
P10	5336156700	CONN., PLUG. 7P
R2	5282416500	VOLUME, IS2U RK181 50KX2 L=20

## CONTROL PCB ASSY (R-9000)

REF. NO.	PARTS NO.	DESCRIPTION
	*5200305250	CONTROL PCB ASSY [J]
	*5200305260	CONTROL PCB ASSY [US]
	*5200305270	CONTROL PCB ASSY [GE]
	*5200305280	CONTROL PCB ASSY [E]
	*5200305290	CONTROL PCB ASSY [UK]
	*5210305200	CONTROL PCB
	*5555900000	PLATE (A), EARTH ; PCB
	*5800990100	HEATSINK
C11	*5730007500	COVER, CAPACITOR SB-1417
	5263166723	C., METAL 0.010UF 50V J VT
C801,803	*5260428210	C., ELEC. 4700/50V
C806	Δ 5260428210	C., ELEC. 4700/50V
C808	Δ 5260429510	C., ELEC. 330UF/50V M AS
C812	Δ 5267703800	C., SPARK KILLER 4700PF/400V
D1-14	5224015020	DIODE, ISS133T77
D15	5224575701	DIODE, ZENER RD11EL2
D16	5224581200	DIODE, ZENER HZ2BLL
D17-21	5224015020	DIODE, ISS133T77
D22,23	5225015820	LED., LTZ-MR15
D24	5224573801	DIODE, ZENER RD6,2EL2
D25	5224572101	DIODE, ZENER RD6,2,6EL1
D26	5224015020	DIODE, ISS133T77
D801-807	Δ 5224013210	DIODE, DSI35D FA4
D808,813	Δ 5224015020	DIODE, ISS133T77
D809	5224579401	DIODE, ZENER RD35EL1
D810	5224574701	DIODE, ZENER RD6,2,EL2
D811,812	5224012920	DIODE, IS2473
J1	5330015100	JACK, IP Y3B21-5129
P1	5336249400	CONN., PLUG B04B-PH-K-S WHT
P2	5336249800	CONN., PLUG B08B-PH-K-S WHT
P3	5336309400	CONN., PLUG B4B-EH-K BLK
P4	5336249600	CONN., PLUG B06B-PH-K-S WHT
P5	5336249700	CONN., PLUG B07B-PH-K-S WHT
P6	5336251600	CONN., PLUG B06B-PH-K-R RED
P7	5336251400	CONN., PLUG B04B-PH-K-R RED
P8	5336255600	CONN., PLUG B06B-PH-K-K BLK
P9	5336253600	CONN., PLUG B06B-PH-K-Y YEL
P10	5336283500	CONN., PLUG B05B-PH-K-Y YEL
P11	5336250000	CONN., PLUG B10B-PH-K-S WHT
P12	5336249500	CONN., PLUG B05B-PH-K-S WHT
P13	5336249500	CONN., PLUG B03B-PH-K-S WHT
P15	5336249200	CONN., PLUG B02B-PH-K-2 WHT
Q1-5	5230780920	TRANSISTOR, 2SC2603F
Q6-8	5232255720	TR., DIGITAL DTC124ES
Q9	5230780920	TRANSISTOR, 2SC2603F
Q10	5230018920	TRANSISTOR, 2SA1115F
Q11-15	5231761300	TRANSISTOR, 2SD734F
Q17	5230780920	TRANSISTOR, 2SC2603F
Q16	5232255720	TR., DIGITAL DTC124ES
Q801	5145085000	TRANSISTOR, 2SA934R
Q802	5230780920	TRANSISTOR, 2SC2603F
Q803,804	5232254820	TR., DIGITAL DT124ES
R31,32	5280021500	R., TRIMMER 22KB
R35	Δ 5241216710	R., INCOM. 33 1W J

Parts marked with \*require longer delivery time.

[J]:JAPAN [US]:U.S.A. [C]:CANADA  
[E]:EUROPE [GE]:GENERAL EXPORT

# R-9000

## CONTROL PCB ASSY (R-9000)

REF.NO.	PARTS NO.	DESCRIPTION
R40	Δ5241182910	R., INCOM. 4.7 1W J
R41	Δ5241215510	R., INCOM. 10 1W J
R51	5242125900	R., ALLEY RYLS-15J223
R57	5280021700	R., TRIMMER 47KB H.
R59	5280021900	R., TRIMMER 100KB
S801	Δ5300054700	SWITCH, PUSH SDDL1 I-1
S802	Δ5332027700	SWITCH, VOLTAGE SELECTOR I-4 FS90BF [GE]
T1	Δ5320058800	TRANSFORMER, POWER
TP1-2	5317002100	PIN, DH CHECK IPS-1136
TP3-7	5317002100	PIN, DH CHECK IPS-1136
U1	5220818600	IC., UCOM. UPD75108CWB23
U2,3	5220427800	IC., BA6209
U4	5220091000	IC., DIGITAL LC7910
U5	5220438500	IC., UPC358C
U6	5220040300	IC., DIGITAL M40690BP
U801	Δ5220434400	IC., M5F7805L
U802	Δ5220439800	IC., L78LR05
U803,805	Δ5220434700	IC., M5F7810L
U804	5220051800	IC., DIGITAL TC74HC04P
X1	5347012000	OSC., CERAMIC CST 4, 19MGW

## FRONT PCB ASSY (R-9000)

REF.NO.	PARTS NO.	DESCRIPTION
	*5200305010	FRONT PCB ASSY
	*5210305000	FRONT PCB
	5801342000	HOLDER, FL
C002,003	5260212950	C., ELEC. 22UF/10V M SRA VT
C004,005	5260212450	C., ELEC. 10UF/25V M SRA VT
C006,007	12907113	C, CC 22000PF/25V Z
D001,002	5225024800	LED., SLP-481C-51 (YEW)
D001,D002	5730034000	SPACER, LS-15
D003-009	5224015020	DIODE, ISS133T-77
D010-026	5224015020	DIODE, ISS133T-77
FL001	5347016900	DISPLAY, FL
P004	5336287700	CONN., PLUG S7B-PH-K-S WHT
P005	5336289600	CONN., PLUG S6B-PH-K-Y YEL
P006	5336289500	CONN., PLUG S5B-PH-K-Y YEL
P007	5336288000	CONN., PLUG S10B-PH-K-S WHT
Q001,003	5232254820	TR., DIGITAL DTA124ES
Q002	5232255720	TR., DIGITAL DTC124ES
Q004	5232255720	TR., DIGITAL DTC124ES
R017,018	5242125800	R., ALLEY RYLS-BJ104
S001-016	5302103200	SWITCH, TACT KHH10910
U001	5292209500	MODULE, REMOCON SBX1483-52
U002-004	5232253300	TR., ARRAY LBI240
U005	5220443400	IC., BA6800AS
U006	5220051600	IC., TC74HC00P

Parts marked with \*require longer delivery time.

[J]:JAPAN [U]:U.S.A. [C]:CANADA  
[E]:EUROPE [GE]:GENERAL EXPORT

## SENSOR PCB ASSY (V-9000)

REF. NO.	PARTS NO.	DESCRIPTION
Q001,002	*5200182400	SENSOR PCB ASSY
	*5210182400	SENSOR PCB
	5228013100	PHOTO REFLEC., NJL5141EA-B

## SWITCH PCB ASSY (V-9000)

REF. NO.	PARTS NO.	DESCRIPTION
D1 S1	*5200305100	SWITCH PCB ASSY
	*5210305100	SWITCH PCB
	5224015020	D1ODE, ISS133T-77
	5301206700	SWITCH, ROTARY SRBM13 L=15 F=04

## R/P AMP PCB ASSY (V-9000)

REF. NO.	PARTS NO.	DESCRIPTION
	*5200304600	R/P AMP PCB ASSY
	*5210304600	R/P AMP PCB
	*5555590000	PLATE (A), EARTH P.C. BOARD
	*5800990100	HEAT SINK
C101,201	5263301120	C., POLY. 150PF/100V J VT
C102,202	5263301320	C., POLY. 330PF/100V J VT
C106,206	5263291820	C., POLY. 0.047UF/100V J VT
C107,207	5263302120	C., POLY. 6800PF/63V J VT
C108,208	5263301720	C., POLY. 1500PF/100V J VT
C109,209	5263293320	C., POLY. 1.0UF/63V J VT
C110,210	5263293320	C., POLY. 1.0UF/63V J VT
C111,211	5263291320	C., POLY. 0.018UF/100V J VT
C112,212	5263302020	C., POLY. 4700PF/63V J VT
C113,213	5263291420	C., POLY. 0.022UF/100V J VT
C114,214	5260473320	C., ELEC. 100UF/16V M PZ VT
C115,215	5263293320	C., POLY. 1.0UF/63V J VT
C121,221	5263166923	C., METAL 0.015MF/50V J VT
C122,222	5263293320	C., POLY. 1.0UF/63V J VT
C124,224	5263167723	C., METAL 0.068UF/50V J VT
C125,225	5263167623	C., METAL 0.056UF/50V J VT
C126,226	5263293320	C., POLY. 1.0UF/63V J VT
C128,228	5263166723	C., METAL 0.010UF/50V J VT
C129,229	5260473320	C., ELEC. 100UF/16V M PZ VT
C131,231	5263291420	C., POLY. 0.022UF/100V J VT
C144,244	Δ5260476910	C., ELEC. 3300UF/25V M PZ VF
C145,245	Δ5260474010	C., ELEC. 220UF/25V M PZ VF
C148,248	5260473320	C., ELEC. 100UF/16V M PZ VT
C149,249	5263291420	C., POLY. 0.022UF/100V J VT
C302,402	5260480620	C., ELEC. 1UF/50V M PZBP VT
C303,403	5260480620	C., ELEC. 1UF/50V M PZBP VT
C310,410	5263166923	C., METAL 0.015MF/50V J VT
C311,411	5260480620	C., ELEC. 1UF/50V M PZBP VT
C313,413	5263167723	C., METAL 0.068UF/50V J VT
C314,414	5263167623	C., METAL 0.056UF/50V J VT

Parts marked with \*require longer delivery time.

## R/P AMP PCB ASSY (V-9000)

REF. NO.	PARTS NO.	DESCRIPTION
C315,415	5260480620	C., ELEC. 1UF/50V M PZBP VT
C317,417	5263166723	C., METAL 0.010UF/50V J VT
C318,418	5260481220	C., ELEC. 10UF 16V M PZBP VT
C319,419	5260481220	C., ELEC. 10UF 16V M PZBP VT
C320,420	5260473320	C., ELEC. 100UF/16V M PZ VT
C322	5260480620	C., ELEC. 1UF 50V M PZBP VT
C324,424	5260472620	C., ELEC. 47UF/10V M PZ VT
C326,426	5260481220	C., ELEC. 10UF 16V M PZBP VT
C327,427	5260473220	C., ELEC. 100UF/10V M PZ VT
C331,431	5263166723	C., METAL 0.010UF/50V J VT
C332,432	5263167523	C., METAL 0.047MF/50V J VT
C333,433	5263167123	C., METAL 0.022UF/50V J VT
C334,434	5263107220	C., POLY. 560PF/100V J VT
C335,435	5263167523	C., METAL 0.047MF/50V J VT
C336,436	5263106420	C., POLY. 270PF/100V J VT
C337,437	5263105420	C., POLY. 100PF/100V J VT
C340	5263167123	C., METAL; 0.022UF/50V J VT
C342	5263101320	C., POLY. 0.0022UF/100V J VT
D101,201	5225015820	LED, LTZ-MR15
D102,202	5225015820	LED, LTZ-MR15
D103-115	5224015020	D1ODE, ISS133T-77
D116	Δ5228010800	SILICON STACK, 52WB10 V870
D118	5224015020	D1ODE, ISS133T-77
D203	5224015020	D1ODE, ISS133T-77
J101	5330510700	JACK, PIN 2P
J102	5330014700	JACK, PIN 3P FJ332DAB-MA
J301	5330510600	JACK, PIN 4P
K101	5290013800	RELAY, DF2-DC12V
L301,302	5286031000	COIL, CHOKE 220UH LAL04KB
L303,403	5286038400	COIL, STEP-UP 210K
L304	5286038600	COIL, OSC 210KHZ
P4	5336249700	CONN., PLUG B07B-PH-K-S WHT
P5	5336303400	CONN., PLUG B4B-EH WHT
P6	5336305400	CONN., PLUG B4B-EH-R RED
P7	5336303200	CONN., PLUG B2B-EH WIT
Q101,201	5232008600	FET., 2SK389BL
Q102-104	5230770100	TRANSISTOR 2SC2240BL
Q105,205	9145162000	TRANSISTOR 2SA-970BL
Q106,206	9145162000	TRANSISTOR 2SA-970BL
Q107-110	9230770100	TRANSISTOR 2SC2240BL
Q111,211	5145162000	TRANSISTOR 2SA-970BL
Q112,212	5230780920	TRANSISTOR 2SC2603F
Q113	5232008420	FET., 2SK381D
Q114,214	5232008420	FET., 2SK381D
Q115,215	5232008420	FET., 2SK381D
Q116	5232255720	TR., DIGITAL DTC124ES
Q117-119	5232254820	TR., DIGITAL DTA124ES
Q120,123	5232254820	TR., DIGITAL DTA124ES
Q121,122	5232255720	TR., DIGITAL DTC124ES
Q124,130	5232255720	TR., DIGITAL DTC124ES
Q125-127	5232254820	TR., DIGITAL DTA124ES
Q128	Δ5231762800	TRANSISTOR 2SD1913R
Q129	Δ5230509700	TRANSISTOR 2SB1274R
Q131	5232254820	TR., DIGITAL DTA124ES
Q202-204	5230770100	TRANSISTOR 2SC2240BL

[J]:JAPAN [US]:U.S.A. [C]:CANADA  
[E]:EUROPE [GE]:GENERAL EXPORT

# V-9000

## R/P AMP PCB ASSY (V-9000)

REF.NO.	PARTS NO.	DESCRIPTION
Q207-210	5230770100	TRANSISTOR 2SC2240BL
Q301,401	5231762020	TRANSISTOR 2SD1450S/T
Q302	5232254820	TR., DIGITAL DTA124ES
Q303	5145089000	TRANSISTOR 2SA-934R
Q304-306	5232255720	TR., DIGITAL DTC124ES
Q307,308	5230780920	TRANSISTOR 2SC2603F
RI	5282416600	VOLUME, 1S2U RK097 100KMN CC L=20
RI01,201	5240571720	R., ERDAIT 47K J
RI02,202	5240567720	R., ERDAIT 1.0K J
RI03,203	5240569320	R., ERDAIT 4.7K J
RI04,204	5240567720	R., ERDAIT 1.0K J
RI05,205	5240564920	R., ERDAIT 68 J
RI06,206	5240568120	R., ERDAIT 1.5K J
RI07,207	5240566520	R., ERDAIT 330 J
RI08,208	5240566520	R., ERDAIT 330 J
RI09,209	5240567520	R., ERDAIT 820 J
RI10,210	5240570120	R., ERDAIT 10K J
RI11,211	5240567920	R., ERDAIT 1.2K J
RI12,212	5240564120	R., ERDAIT 33 J
RI13,213	5240568720	R., ERDAIT 2.7K J
RI14,214	5240568320	R., ERDAIT 1.8K J
RI15,215	5240567920	R., ERDAIT 1.2K J
RI16,216	5240564120	R., ERDAIT 33 J
RI17,217	5240564120	R., ERDAIT 33 J
RI18,218	5240572120	R., ERDAIT 68K J
RI19,219	5240568720	R., ERDAIT 2.7K J
RI20,220	5240567820	R., ERDAIT 1.1K J
RI21,221	5240569220	R., ERDAIT 4.3K J
RI22,222	5240569420	R., ERDAIT 5.1K J
RI23,223	5240569520	R., ERDAIT 5.6K J
RI24,224	5240572920	R., ERDAIT 150K J
RI25,225	5240572920	R., ERDAIT 150K J
RI26,226	5240568720	R., ERDAIT 2.7K J
RI27,227	5240568720	R., ERDAIT 2.7K J
RI29,229	5280021300	R., TRIMMER 10KB H.
RI30,230	5280021700	R., TRIMMER 47KB H.
RI55,255	5240569320	R., ERDAIT 4.7K J
RI56,256	5240566920	R., ERDAIT 470 J
RI60	5280021700	R., TRIMMER 47KB H.
RI84	5241461020	R., METAL 15K F
RI85	5241459420	R., METAL 3.3K F
RI86,286	5241461020	R., METAL 15K F
RI88,288	5240566920	R., ERDAIT 470 J
R3	5282416800	VOLUME, 1S2U RK097 20KBX2 CC L=20
R301,401	5240570720	R., ERDAIT 18K J
R302,402	5240570720	R., ERDAIT 18K J
R327,427	5240570120	R., ERDAIT 10K J
R330,430	5280021300	R., TRIMMER 10KB H.
R332,R432	5240568320	R., ERDAIT 1.8K J
R360	5280021500	R., TRIMMER 22KB H.
R361	5280021300	R., TRIMMER 10KB H.
R364,464	5280021300	R., TRIMMER 10KB H.
R4	5282022400	VOLUME, 1S1U RK097 5KB CC L=20
R5	5282416700	VOLUME, 1S2U RK097 20KAX2 L=20
S1	5301206800	SWITCH, ROTARY SREMI3 L=20 F=10

## R/P AMP PCB ASSY (V-9000)

REF.NO.	PARTS NO.	DESCRIPTION
S2,3	5300054600	SWITCH, PUSH SPUR 2-2 NS
S4	5300054500	SWITCH, PUSH SPUR 2-2 NS
TP1-10	5317002100	PIN, DI CHECK IPS-1136
U101,201	5220439500	IC., UPC4570HA
U102,202	5286038800	COIL, TRAP 210KHZ
U103,302	5220439500	IC., UPC4570HA
U104,303	5220443300	IC., CX20188
U105	5220426200	IC., M51143AL
U106	5220092400	IC., DIGITAL BU4052B
U107	5220425800	IC., M5250LA
U301,401	5292805600	FILTER, LOWPASS MPX
U304	5220439700	IC., CXAI198AF
U305,405	5286038800	COIL, TRAP 210KHZ
U306	5220434500	IC., M5F7807L
U307	5220435400	IC., M5F7907L
U308	5220430400	IC., UPC1297CA,

Parts marked with \*require longer delivery time.

[J]:JAPAN [U]:U.S.A. [C]:CANADA  
[E]:EUROPE [G]:GENERAL EXPORT



## R/P SUB PCB ASSY (V-9000)

REF.NO.	PARTS NO.	DESCRIPTION
	*5200304700	R/P SUB PCB ASSY
	*5210304700	R/P SUB PCB
C501,601	5260481220	C., 10UF/16V M PZBP VT
C504	5263166923	C., METAL 0.015MF/50V J VT
C511,611	5260480620	C., 1UF/50V M PZBP VT
C512,612	5263167923	C., METAL 0.1MF/50V J VT
C513,613	5260472720	C., 47UF/16V M PZ VT
C514,517	5263166723	C., METAL 0.010UF/50V J VT
C518,519	5263167223	C., METAL 0.027UF/50V J VT
C520	5260481220	C., 10UF/16V M PZBP VT
D501-505	5224015020	DIODE, 1SS133T-77
D601	5224015020	DIODE, 1SS133T-77
P8	5336291500	CONN., PLUG 55B-PH-K-R RED
P9	5336156900	CONN., PLUG 9P
P10,11	5336156400	CONN., PLUG 4P
P12	5336302100	CONN., PLUG 11P 9059
Q501,503	5232008420	FET., 2SK381D
Q502,504	5230780920	TRANSISTOR 2SC2603F
R505,605	5280036300	R., TRIMMER 10KB
R508,608	5280036700	R., TRIMMER 47KB
R533,633	5240563920	R., 27 J ERDAIT
R543,554	5280036300	R., TRIMMER 10KB
TP11,12	5317002100	PIN, DH CHECK IPS-1136
U501,601	5220439500	IC., UPC4570HA
U502,503	5220439500	IC., UPC4570HA
U904	5220438700	IC., LA651D
U905	5220439500	IC., UPC4570HA

## VR PCB ASSY (V-9000)

REF.NO.	PARTS NO.	DESCRIPTION
	*5200304800	VR PCB ASSY
	*5210304800	VR PCB
P10	5336156700	CONN., PLUG 7P
R2	5282416500	VOLUME, 152U RK181 50KX2 L=20

## CONTROL PCB ASSY (V-9000)

REF.NO.	PARTS NO.	DESCRIPTION
	*5200305200	CONTROL PCB ASSY [J]
	*5200305210	CONTROL PCB ASSY [US1]
	*5200305220	CONTROL PCB ASSY [GE]
	*5200305230	CONTROL PCB ASSY [E]
	*5200305240	CONTROL PCB ASSY [UK1]
	*5210305200	CONTROL PCB
	*5555590000	PLATE (A), EARTH ; PCB
	*5800990100	HEAT SINK
	5730007000	COVER, CAPASITOR 5B-1417
C6,8	12908842	C., CC 0.1UF/50V Z
C11	5263166723	C., METAL 0.010UF 50V J VT
CB01,803	*5260428210	C., ELEC. 4700/50V
CB06	*5260428210	C., ELEC. 4700/50V
CB08	*5260429510	C., ELEC. 330UF/50V M AS
CB12	*5267703800	C., SPARK KIL. 4700PF/400V M
D1,3	5224015020	DIODE, 1SS133T-77
D5-10	5224015020	DIODE, 1SS133T-77
D13	5224015020	DIODE, 1SS133T-77
D15	5224575701	DIODE, ZENER RD11EL2
D16	5224581200	DIODE, ZENER HZ26LL
D18,19	5224015020	DIODE, 1SS133T-77
D24	5224573801	DIODE, ZENER RD6.2EL2
D25	5224572101	DIODE, ZENER RD3.6EL1
D801-807	*5224013210	DIODE, DS135D FA4
D808,813	*5224015020	DIODE, 1SS133T-77
D809	5224579401	DIODE, ZENER RD33EL1
DB10	5224574701	DIODE, ZENER RD8.2EL2
DB11,812	5224012920	DIODE, IS2473
J1	5330015100	JACK, 1P YKB21-5129
P1	5336249400	CONN., PLUG B04B-PH-K-S WHT
P2	5336249800	CONN., PLUG B08B-PH-K-S WHT
P3	5336309400	CONN., PLUG B4B-EH-K BLK
P4	5336249600	CONN., PLUG B06B-PH-K-S WHT
P5	5336249700	CONN., PLUG B07B-PH-K-S WHT
P6	5336251600	CONN., PLUG B06B-PH-K-R RED
P7	5336251400	CONN., PLUG B04B-PH-K-R RED
P8	5336255600	CONN., PLUG B06B-PH-K-K BLK
P9	5336253600	CONN., PLUG B06B-PH-K-Y YEL
P10	5336253500	CONN., PLUG B05B-PH-K-Y YEL
P11	5336250000	CONN., PLUG B10B-PH-K-S WHT
P12	5336249300	CONN., PLUG B03B-PH-K-S WHT
P15	5336249200	CONN., PLUG B02B-PH-K-S WHT
Q1-5	5230780920	TRANSISTOR 2SC2603F
Q6-8	5232255720	TR., DIGITAL DTC124ES
Q9	5230780920	TRANSISTOR 2SC2603F
Q10	5230018920	TRANSISTOR 2SA1115F
Q11,12	5231761300	TRANSISTOR 2SD734F
Q16	5232255720	TR., DIGITAL DTC124ES
Q801	*5145085000	TRANSISTOR 2SA934R
Q802	5230780920	TRANSISTOR 2SC2603F
Q803	5232254820	TR., DIGITAL DTA124ES
Q804	5232255720	TR., DIGITAL DTC124ES
R31	5280021500	R., TRIMMER 22KB H.
R35	*5241217510	R., INCOM. 6B 1W J
R40	*5241182910	R., INCOM. 4.7 1W J

Parts marked with \*require longer delivery time.

[J]:JAPAN [US1]:U.S.A. [C]:CANADA  
[E]:EUROPE [GE]:GENERAL EXPORT

# V-9000

## CONTROL PCB ASSY (V-9000)

REF.NO.	PARTS NO.	DESCRIPTION
R41	△5241215510	R., INCOM. 10 1W J
R51	5242123900	R., ALLAY RYLS-15J223
S801	△5300054700	SWICH, PUSH SDDL1 1-1
S802	5332027700	SWITCH, VOLTAGE SELECTOR 1-4 FS908F
T1	△5320058800	TRANSFORMER, POWER
TP1-2	5317002100	PIN, DH CHECK 1P5-1136
U1	5220818600	IC., UCOM. UP075108CW-823
U2,3	5220427800	IC., BA6209
U4	5220091000	IC., DIGITAL LC7910
U801	△5220434400	IC., MSF7805L
U802	△5220439800	IC., L78LR05
U803,805	△5220434700	IC., MSF7810L
U804	5220051800	IC., TC74HC04P
X1	5347012000	OSC., CERAMIC CST 4, 19MGW

## FRONT PCB ASSY (V-9000)

REF.NO.	PARTS NO.	DESCRIPTION
	*5200305000	FRONT PCB ASSY
	*5210305000	FRONT PCB
C1	5263166923	C., METAL 0.015MF/50V J VT
D3-8	5224015020	DIODE, ISS133T-77
D10-15	5224015020	DIODE, ISS133T-77
D17-26	5224015020	DIODE, ISS133T-77
FL1	5347016900	DISPLAY, FL
P4	5336287700	CONN., PLUG S7B-PH-K-S WHT
P5	5336289600	CONN., PLUG S6B-PH-K-Y YEL
P6	5336289500	CONN., PLUG S5B-PH-K-Y YEL
P7	5336288000	CONN., PLUG S10B-PH-K-S WHT
Q1,3	5232254820	TR., DIGITAL DTA124ES
Q2,4	5232255720	TR., DIGITAL DTC124ES
R17,18	5242125800	R., ARRY RYLS-BJ104
S1-6	5302103200	SWITCH, TACT KHH10910
S8,13	5302103200	SWITCH, TACT KHH10910
S15,16	5302103200	SWITCH, TACT KHH10910
U1	5292209500	MODULE, REMOCON SBX1483-52
U2	5232253300	TR., ARRAY LB1240
U3	5232253300	TR., ARRAY LB1240
U4	5232253300	TR., ARRAY LB1240
U5	5220443400	IC., BA6800AS
U6	5220051600	IC., TC74HC00P



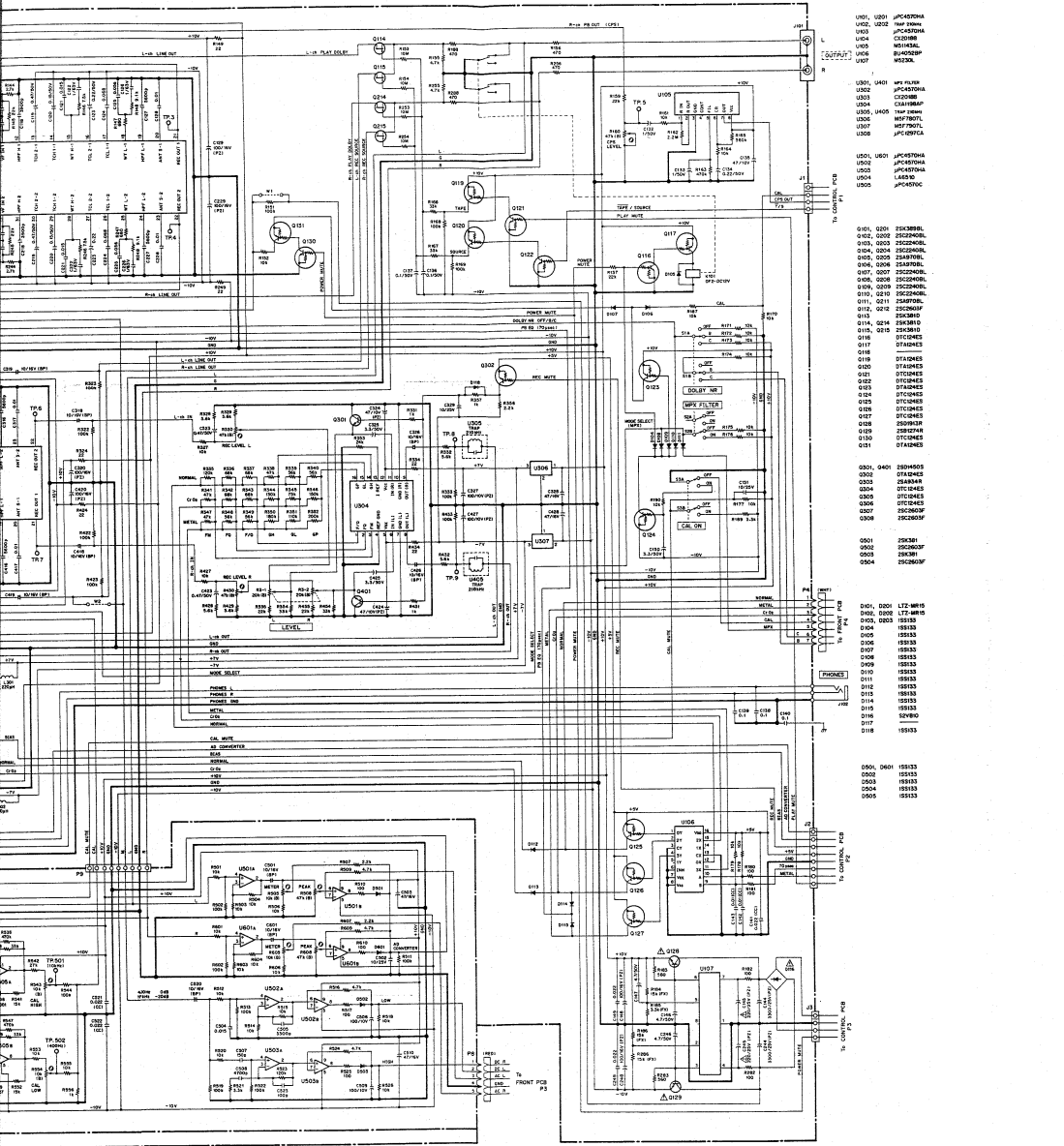

# TEAC SCHEMATIC DIAGRAM (CONTROL) V-9000

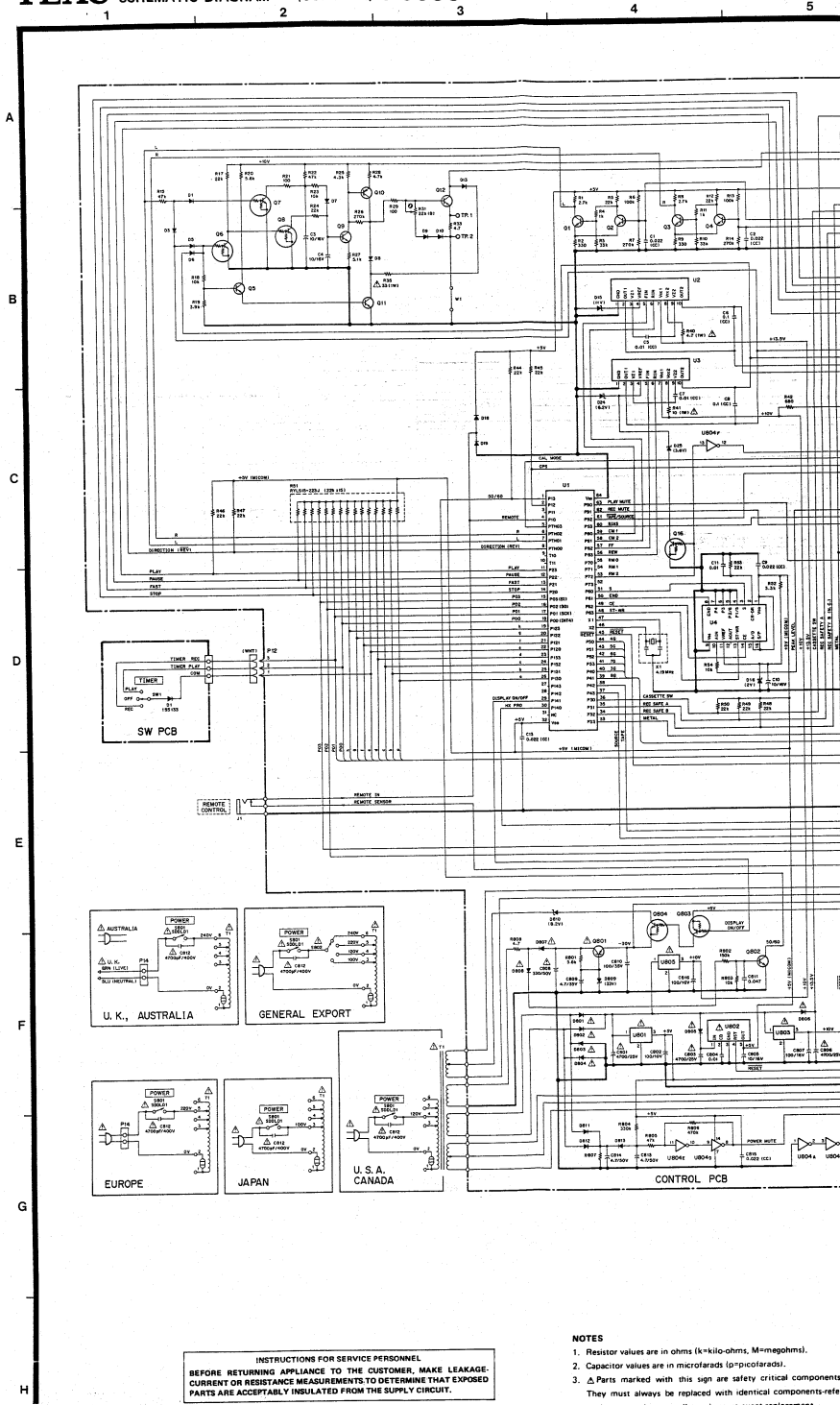

INSTRUCTIONS FOR SERVICE PERSONNEL  
 BEFORE RETURNING APPLIANCE TO THE CUSTOMER, MAKE LEAKAGE  
 CURRENT OR RESISTANCE MEASUREMENTS TO DETERMINE THAT EXPOSED  
 PARTS ARE ACCEPTABLY INSULATED FROM THE SUPPLY CIRCUIT.

### NOTES

1. Resistor values are in ohms (k=kilo-ohms, M=megohms).
2. Capacitor values are in microfarads (p=picofarads).
3.  $\Delta$  Parts marked with this sign are safety critical components. They must always be replaced with identical components—refer to the appropriate parts list and ensure exact replacement.

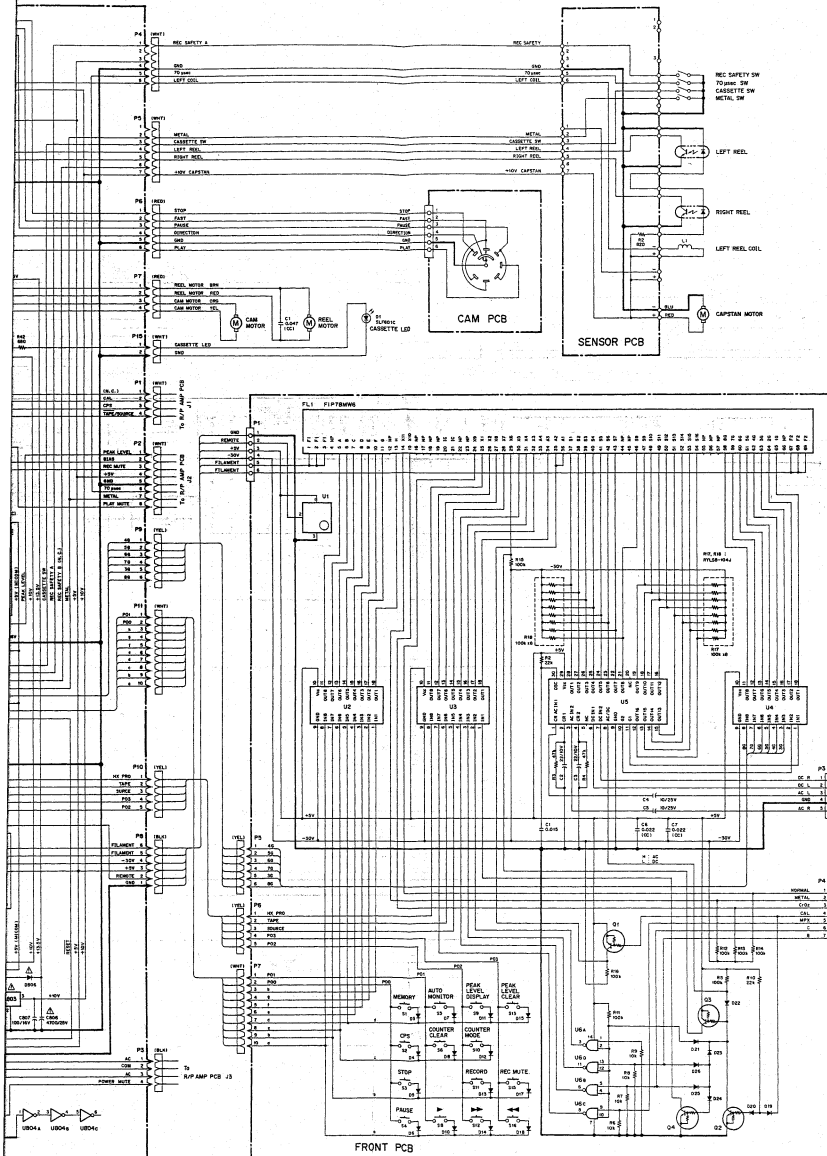

CONTROL PCB

- U1 μPC9108C/R3M
- U2 BA8209P
- U3 BA8209
- U4 L6790
  
- UB01 M43790L
- UB02 L76L005
- UB03 M43790L
- UB04 TC7HC04AP
- UB05 M43790L
  
- O1 2SC9605P
- O2 2SC9605P
- O3 2SC9605P
- O4 2SC9605P
- O5 2SC9605P
- O6 2SC9605P
- O7 01C0405
- O8 2SC9605P
- O9 2SC9605P
- O10 2SC9605P
- O11 2SD754F
- O12 2SD754F
- O13
- O14
- O15
- O16 TC7C4245
  
- OB01 2SA5506
- OB02 2SC9605P
- OB03 TC7C4245
- OB04 TC7C4245
  
- D1 1S9133
- D2 1S9133
- D3 1S9133
- D4 1S9133
- D5 1S9133
- D6 1S9133
- D7 1S9133
- D8 1S9133
- D9 1S9133
- D10 1S9133
- D11
- D12
- D13 1S9133
- D14 1S9133
- D15 1S9133
- D16 HZ8RLL
- D17
- D18 1S9133
- D19 1S9133
- D20
- D21
- D22
- D23
- D24 R06.2E1.2
- D25 R06.4E1.1
  
- OB01 09105
- OB02 09105
- OB03 09105
- OB04 09105
- OB05 09105
- OB06 09105
- OB07 09105
- OB08 1S9133
- OB09 R06.2E1.2
- OB10 R06.2E1.2
- OB11 1S2473
- OB12 1S2473
- OB13 1S2473

FRONT PCB

- U1 L6340
- U2 L6340
- U3 L6340
- U4 L6340
- U5 BA8080AS
- U6 TC7HC04AP
  
- O1 2FA124E5
- O2 2FA124E5
- O3 2FA124E5
- O4 2FA124E5
  
- D1
- D2 1S9133
- D3 1S9133
- D4 1S9133
- D5 1S9133
- D6 1S9133
- D7 1S9133
- D8
- D9
- D10 1S9133
- D11 1S9133
- D12 1S9133
- D13 1S9133
- D14 1S9133
- D15 1S9133
- D16 1S9133
- D17 1S9133
- D18 1S9133
- D19 1S9133
- D20 1S9133
- D21 1S9133
- D22 1S9133
- D23 1S9133
- D24 1S9133
- D25 1S9133

注意

1. 抵抗の単位はΩ(k=千Ω, M=MΩ)です。
2. コンデンサの単位はμF(p=pF)です。
3. △マークのある部品は安全重要部品です。交換するときは必ずティアック指定の部品を使用してください。

# V-9000 Stereo Cassette Deck

# TEAC SCHEMATIC DIAGRAM (AMPLIFIER) R-9000

1

2

3

4

5

A

B

C

D

E

F

G

H

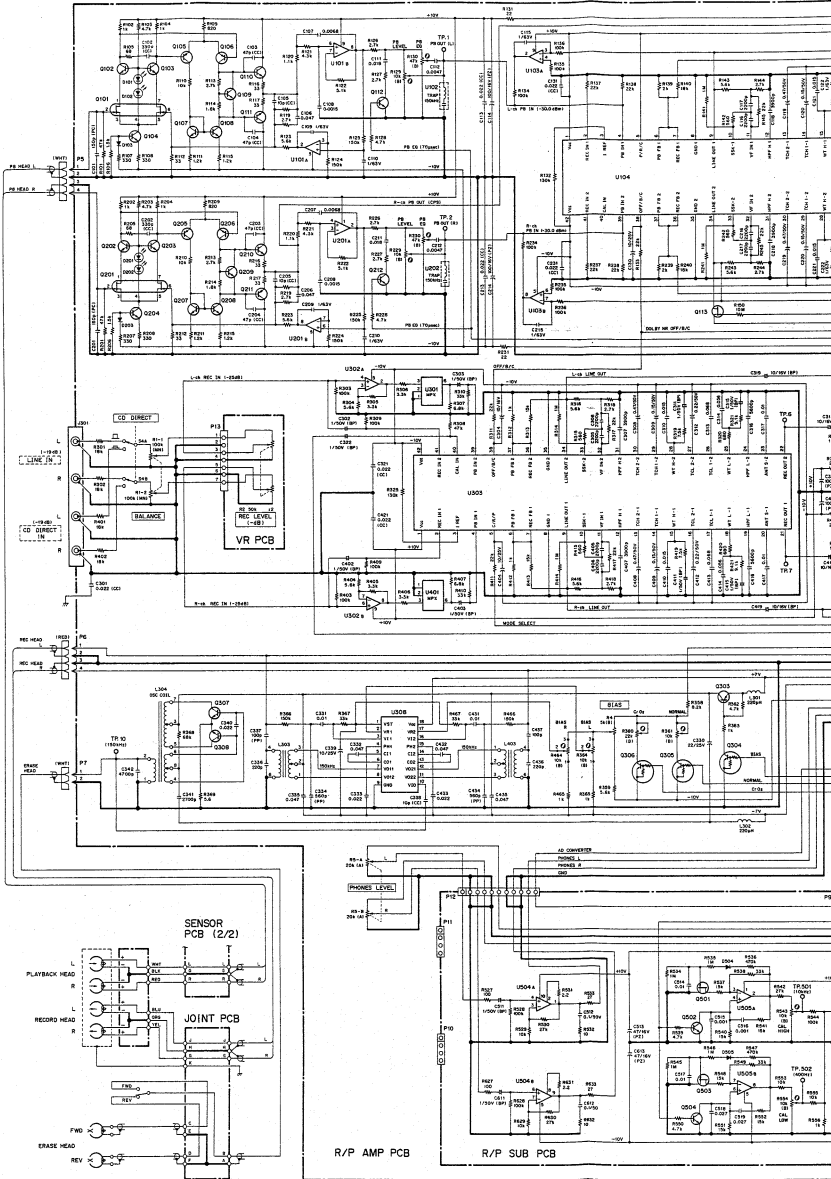

INSTRUCTIONS FOR SERVICE PERSONNEL  
**BEFORE RETURNING APPLIANCE TO THE CUSTOMER, MAKE LEAKAGE-CURRENT OR RESISTANCE MEASUREMENTS TO DETERMINE THAT EXPOSED PARTS ARE ACCEPTABLY INSULATED FROM THE SUPPLY CIRCUIT.**

**NOTES**

1. Resistor values are in ohms (k=kilo-ohms, M=megohms).
2. Capacitor values are in microfarads (μ=picofarads).
3. Δ Parts marked with this sign are safety critical components. They must always be replaced with identical components—refer to the appropriate parts list and ensure exact replacement.

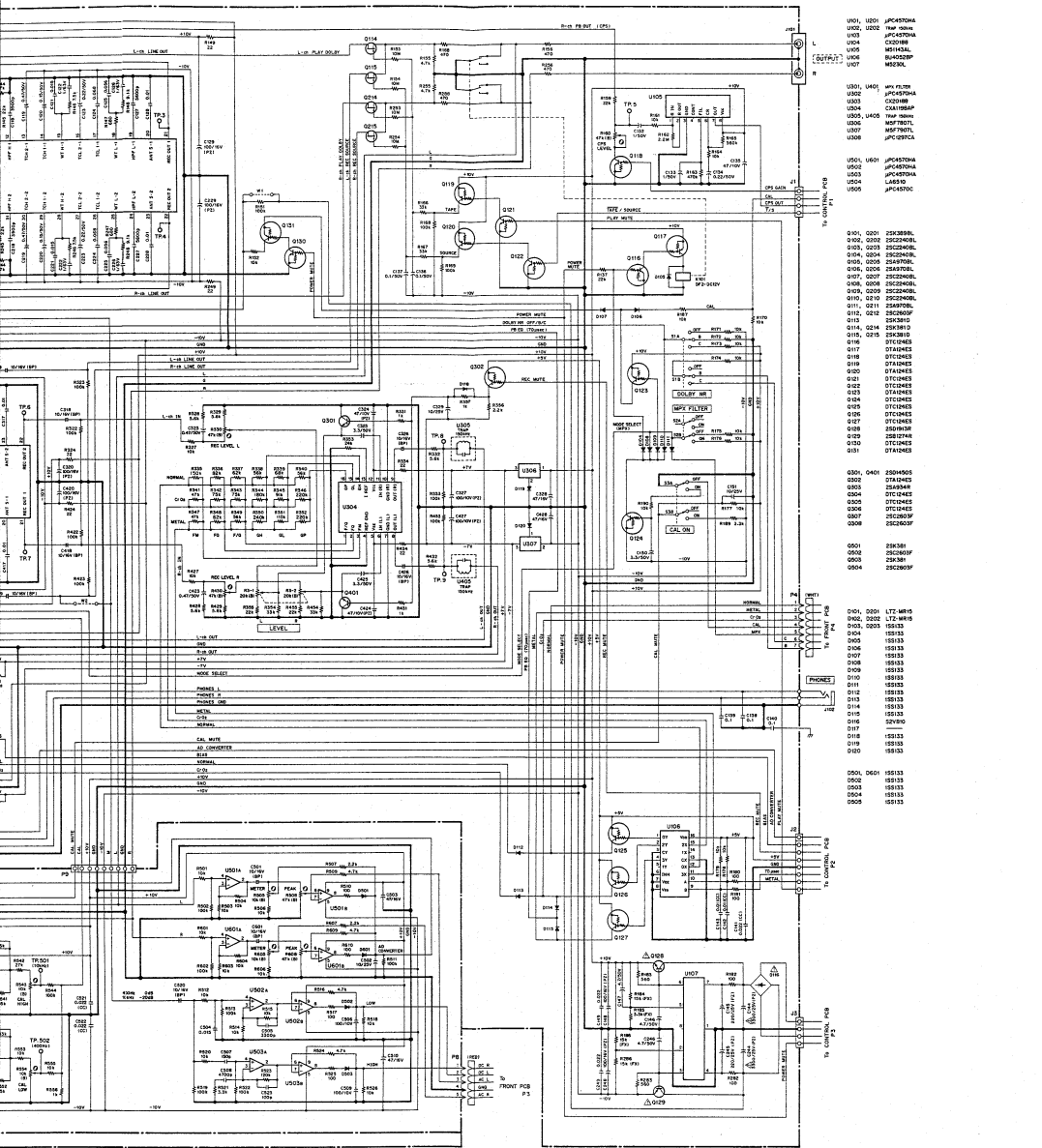

- U101, U102, U103, U104, U105, U106, U107
- U101, U102, U103, U104, U105, U106, U107

- U101, U102, U103, U104, U105, U106, U107
- U101, U102, U103, U104, U105, U106, U107

- U101, U102, U103, U104, U105, U106, U107
- U101, U102, U103, U104, U105, U106, U107

- Q101, Q102, Q103, Q104, Q105, Q106, Q107, Q108, Q109, Q110, Q111, Q112, Q113, Q114, Q115, Q116, Q117, Q118, Q119, Q120, Q121, Q122, Q123, Q124, Q125

- Q101, Q102, Q103, Q104, Q105, Q106, Q107, Q108, Q109, Q110, Q111, Q112, Q113, Q114, Q115, Q116, Q117, Q118, Q119, Q120, Q121, Q122, Q123, Q124, Q125

- Q101, Q102, Q103, Q104, Q105, Q106, Q107, Q108, Q109, Q110, Q111, Q112, Q113, Q114, Q115, Q116, Q117, Q118, Q119, Q120, Q121, Q122, Q123, Q124, Q125

- Q101, Q102, Q103, Q104, Q105, Q106, Q107, Q108, Q109, Q110, Q111, Q112, Q113, Q114, Q115, Q116, Q117, Q118, Q119, Q120, Q121, Q122, Q123, Q124, Q125

- Q101, Q102, Q103, Q104, Q105, Q106, Q107, Q108, Q109, Q110, Q111, Q112, Q113, Q114, Q115, Q116, Q117, Q118, Q119, Q120, Q121, Q122, Q123, Q124, Q125

- Q101, Q102, Q103, Q104, Q105, Q106, Q107, Q108, Q109, Q110, Q111, Q112, Q113, Q114, Q115, Q116, Q117, Q118, Q119, Q120, Q121, Q122, Q123, Q124, Q125

- Q101, Q102, Q103, Q104, Q105, Q106, Q107, Q108, Q109, Q110, Q111, Q112, Q113, Q114, Q115, Q116, Q117, Q118, Q119, Q120, Q121, Q122, Q123, Q124, Q125

- Q101, Q102, Q103, Q104, Q105, Q106, Q107, Q108, Q109, Q110, Q111, Q112, Q113, Q114, Q115, Q116, Q117, Q118, Q119, Q120, Q121, Q122, Q123, Q124, Q125

- Q101, Q102, Q103, Q104, Q105, Q106, Q107, Q108, Q109, Q110, Q111, Q112, Q113, Q114, Q115, Q116, Q117, Q118, Q119, Q120, Q121, Q122, Q123, Q124, Q125

- Q101, Q102, Q103, Q104, Q105, Q106, Q107, Q108, Q109, Q110, Q111, Q112, Q113, Q114, Q115, Q116, Q117, Q118, Q119, Q120, Q121, Q122, Q123, Q124, Q125

- Q101, Q102, Q103, Q104, Q105, Q106, Q107, Q108, Q109, Q110, Q111, Q112, Q113, Q114, Q115, Q116, Q117, Q118, Q119, Q120, Q121, Q122, Q123, Q124, Q125

- Q101, Q102, Q103, Q104, Q105, Q106, Q107, Q108, Q109, Q110, Q111, Q112, Q113, Q114, Q115, Q116, Q117, Q118, Q119, Q120, Q121, Q122, Q123, Q124, Q125

注意  
 1. 抵抗の単位はΩ(k=kΩ, M=MΩ)です。  
 2. コンデンサの単位はμF(p=pF)です。  
 3. △マークのある部品は安全重要部品です。  
 交換するときは必ずタイプ指定の部品を使用してください。

# R-9000 Stereo Cassette Deck





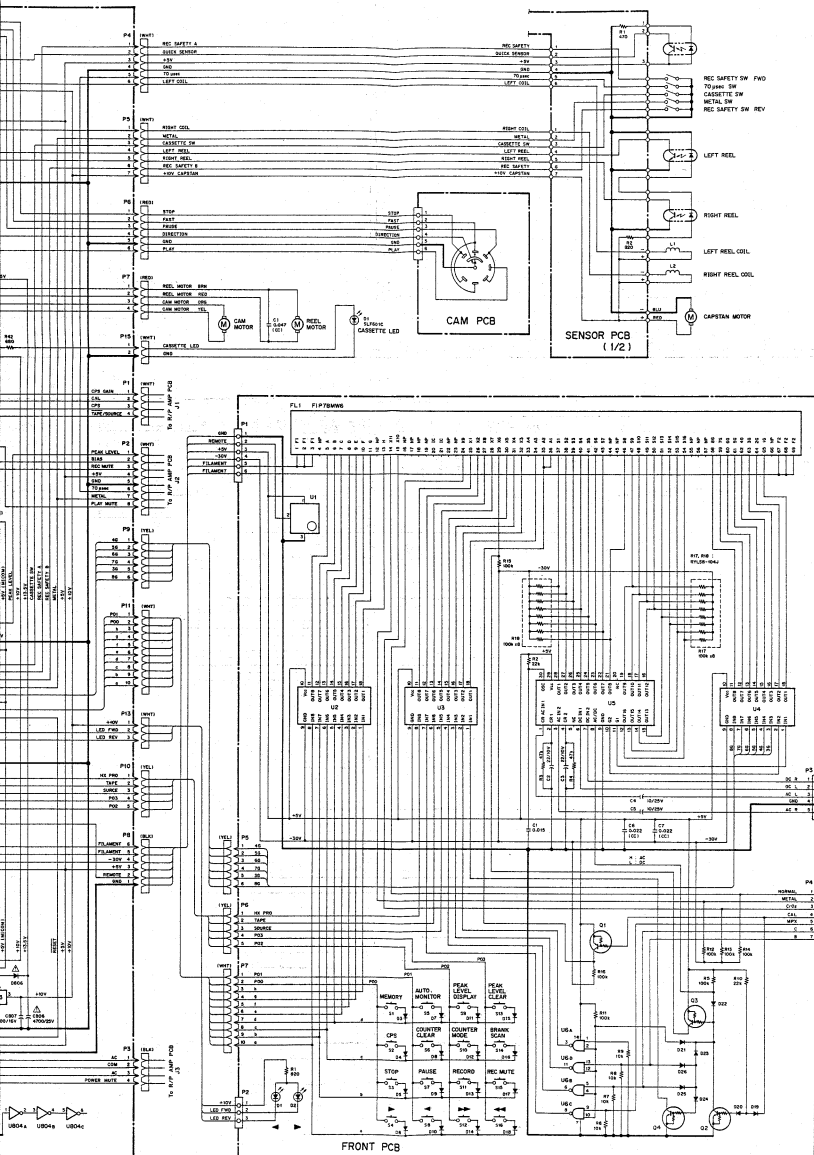

CONTROL PCB

- U1 JPT1000000-B38
- U2 B4620P
- U3 J2C200P
- U4 L7910
- U5 47C45C
- U6 M4065UP
- UR01 MPTF00L
- UR02 UL7900
- UR03 MPTF00L
- UR04 TC79000AP
- UR05 MPTF00L
- O1 2C200P
- O2 2C200P
- O3 2C200P
- O4 2C200P
- O5 2C200P
- O6 2TC245
- O7 2TC245
- O8 2TC245
- O9 2C200P
- O10 2S415P
- O11 2D204P
- O12 2D204P
- O13 2D204P
- O14 2D204P
- O15 2D204P
- O16 2TC245
- O17 2C200P
- OR01 2S484R
- OR02 2C200P
- OR03 2C245C
- OR04 2TC245
- O1 2S203
- O2 2S203
- O3 2S203
- O4 2S203
- O5 2S203
- O6 2S203
- O7 2S203
- O8 2S203
- O9 2S203
- O10 2S203
- O11 2S203
- O12 2S203
- O13 2S203
- O14 2S203
- O15 2S203
- O16 2S203
- O17 2S203
- O18 2S203
- O19 2S203
- O20 2S203
- O21 2S203
- O22 2S203
- O23 2S203
- O24 2S203
- O25 2S203
- O26 2S203
- O27 2S203
- O28 2S203
- O29 2S203
- O30 2S203
- O31 2S203
- O32 2S203
- O33 2S203
- O34 2S203
- O35 2S203
- O36 2S203
- O37 2S203
- O38 2S203
- O39 2S203
- O40 2S203
- O41 2S203
- O42 2S203
- O43 2S203
- O44 2S203
- O45 2S203
- O46 2S203
- O47 2S203
- O48 2S203
- O49 2S203
- O50 2S203
- O51 2S203
- O52 2S203
- O53 2S203
- O54 2S203
- O55 2S203
- O56 2S203
- O57 2S203
- O58 2S203
- O59 2S203
- O60 2S203
- O61 2S203
- O62 2S203
- O63 2S203
- O64 2S203
- O65 2S203
- O66 2S203
- O67 2S203
- O68 2S203
- O69 2S203
- O70 2S203
- O71 2S203
- O72 2S203
- O73 2S203
- O74 2S203
- O75 2S203
- O76 2S203
- O77 2S203
- O78 2S203
- O79 2S203
- O80 2S203
- O81 2S203
- O82 2S203
- O83 2S203
- O84 2S203
- O85 2S203
- O86 2S203
- O87 2S203
- O88 2S203
- O89 2S203
- O90 2S203
- O91 2S203
- O92 2S203
- O93 2S203
- O94 2S203
- O95 2S203
- O96 2S203
- O97 2S203
- O98 2S203
- O99 2S203
- O100 2S203

FRONT PCB

- U1 28B14B3-02
- U2 L2920
- U3 L2920
- U4 L2920
- U5 B4620A08
- U6 J2C200P
- O1 2TC245
- O2 2TC245
- O3 2TC245
- O4 2TC245
- O1 2LP-48C
- O2 2LP-48C
- O3 2S203
- O4 2S203
- O5 2S203
- O6 2S203
- O7 2S203
- O8 2S203
- O9 2S203
- O10 2S203
- O11 2S203
- O12 2S203
- O13 2S203
- O14 2S203
- O15 2S203
- O16 2S203
- O17 2S203
- O18 2S203
- O19 2S203
- O20 2S203
- O21 2S203
- O22 2S203
- O23 2S203
- O24 2S203
- O25 2S203
- O26 2S203
- O27 2S203
- O28 2S203
- O29 2S203
- O30 2S203
- O31 2S203
- O32 2S203
- O33 2S203
- O34 2S203
- O35 2S203
- O36 2S203
- O37 2S203
- O38 2S203
- O39 2S203
- O40 2S203
- O41 2S203
- O42 2S203
- O43 2S203
- O44 2S203
- O45 2S203
- O46 2S203
- O47 2S203
- O48 2S203
- O49 2S203
- O50 2S203
- O51 2S203
- O52 2S203
- O53 2S203
- O54 2S203
- O55 2S203
- O56 2S203
- O57 2S203
- O58 2S203
- O59 2S203
- O60 2S203
- O61 2S203
- O62 2S203
- O63 2S203
- O64 2S203
- O65 2S203
- O66 2S203
- O67 2S203
- O68 2S203
- O69 2S203
- O70 2S203
- O71 2S203
- O72 2S203
- O73 2S203
- O74 2S203
- O75 2S203
- O76 2S203
- O77 2S203
- O78 2S203
- O79 2S203
- O80 2S203
- O81 2S203
- O82 2S203
- O83 2S203
- O84 2S203
- O85 2S203
- O86 2S203
- O87 2S203
- O88 2S203
- O89 2S203
- O90 2S203
- O91 2S203
- O92 2S203
- O93 2S203
- O94 2S203
- O95 2S203
- O96 2S203
- O97 2S203
- O98 2S203
- O99 2S203
- O100 2S203

- 注意
1. 抵抗の単位はΩ(k=10<sup>3</sup>, M=10<sup>6</sup>)です。
  2. コンデンサの単位はμF(p=10<sup>-12</sup>)です。
  3. ムネアツのある部品は安全重要部品です。
- 交換するときは必ずタイプアップ指定の部品を使用してください。

# R-9000 Stereo Cassette Deck